



Telecommunications
Telekomunikacije

Antennas, Electronics and
Accessories

Antene, elektronika in
pribor



Iskra ranks among the leading Central European companies in the fields of energy, efficient installations, traffic, telecommunications, information technology and business solutions. We have long experience in developing and manufacturing devices, and wide engineering knowledge in realizing demanding projects in the fields of energy, industrial processes and information solutions. Our products and solutions are present in over 80 countries on all continents.

Iskra je eno vodilnih vodilnih srednjeevropskih podjetij na področjih energetike, komponent s področja elektrotehnike, učinkovitih inštalacij, prometa, telekomunikacij, informatike ter varovanja, oskrbe in upravljanja poslovnih objektov. Imamo sedemdesetletne izkušnje pri razvoju in proizvodnji naprav ter bogato inženirsko znanje pri realizaciji najzahtevnejših projektov na področjih energetike, telekomunikacij, prometa in industrijskih procesov.

Naši kupci so multinacionalke z različnih področij, ki segajo od težke industrije, energetike, bele tehnike do obnovljivih virov. S svojimi izdelki, storitvami in rešitvami smo prisotni v več kot 80 državah na vseh kontinentih.

About Antennas Systems

The programme of antenna systems originates from the former company "Iskra Antene" with a history that goes back to 1955, the year of the foundation of the company "Elektron". From the start, the programme has been involved in products for radio, T.V. & telecommunications. We supply a comprehensive range of products for the reception of analogue and digital terrestrial & mobile telecommunication signals.

Zgodovina programa ANTENE

Njena zgodovina sega v leto 1955, ko je bilo ustanovljeno podjetje Elektron. Že vse od ustanovitve se je podjetje ukvarjalo z izdelki za radio, TV in mobilne telekomunikacije. Danes podjetje ponuja zaokroženo paleto izdelkov za sprejem analognih in digitalnih satelitskih in zemeljskih signalov.

Milestones / Mejniki

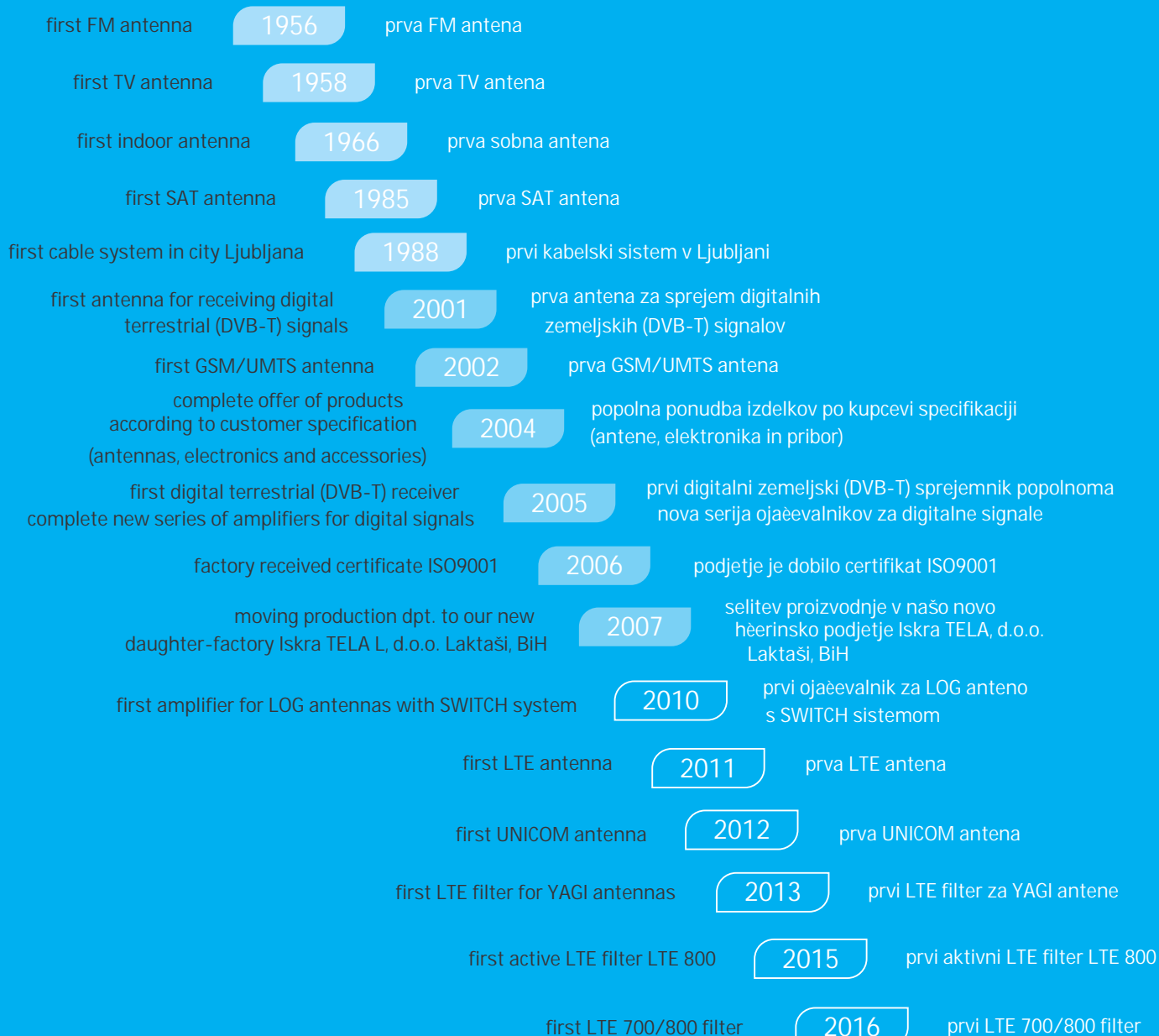

ANTENNAS / ANTENE

2

■ Radio Antennas / Radijske antene	3
■ LOG Antennas - Descriptions / LOG antene - Opis	4
■ LOG Antennas - VHF / LOG antene - VHF	7
■ LOG Antennas - UHF / LOG antene - UHF	8
■ LOG Antennas - VHF/UHF / LOG antene - VHF/UHF	11
■ Built-in Antennas Amplifiers for LOG antennas / Vgrajeni antenski ojačevalniki za LOG antene	13
■ YAGI Antennas - Descriptions / YAGI antene - Opis	15
■ YAGI antennas - Channel Antennas / YAGI antene - kanalne	17
■ YAGI antennas - VHF / YAGI antene - VHF	18
■ YAGI Antennas - series DTX / YAGI antene - serija DTX	19
■ YAGI Antennas - series DTM / YAGI antene - serija DTM	21
■ YAGI antennas / YAGI antene	23
■ Antennas Amplifier for YAGI antennas / Antenski ojačevalniki za YAGI antene	25
■ LTE Filters for LOG and YAGI Antennas / LTE filtri za LOG in YAGI antene	27
■ Indoor Antennas / Sobne antene	29
■ Professional Antennas / Profesionalne antene	30
■ Professional Antennas - UMTS / Profesionalne antene - UMTS	31
■ Professional Antennas - NMT, GSM / Profesionalne antene - NMT, GSM	32
■ Professional Antennas - WLAN / Profesionalne antene - WLAN	34
■ Professional Antennas - Wi-Fi, LTE / Profesionalne antene - Wi-Fi, LTE	35
■ Professional Antennas - UNICOM / Profesionalne antene - UNICOM	36
■ Professional Antennas - MiMo / Profesionalne antene - MiMo	37

ANTENNAS ELECTRONICS / ANTENSKA ELEKTRONIKA

■ Antennas Amplifiers / Antenski ojačevalniki	39
■ Antennas Power Suppliers / Antenski napajalniki	41
■ Couplers / Kretnice	42
■ Accessories / Pribor	43

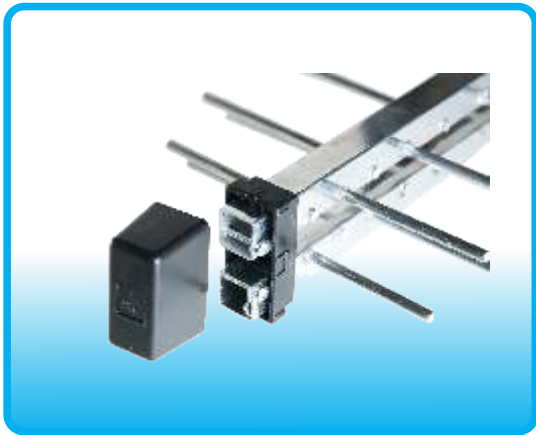

All ISKRA antennas are optimized for best signal reception in the frequency band for which they are intended. A major feature of the antennas we produce is that they all have a built-in type »F« female connector for simple installation of the coaxial cable to the antenna.

Antennas are constructed with aluminium alloy type EN AW 3005 (AlMn1Mg0,5) H165, which has high mechanical strength and resistance to the most adverse weather & temperature variations throughout the world.

All metal parts are made from hot galvanized steel that is corrosion resistant and plastic components are made of plastic which is UV resistant. That ensures quality and longevity of the product.

Antennas are individually packaged in PVC bags, some having a cardboard header with technical instructions for in-store placement & visual product promotion.

We can also supply antennas which are packaged in the individual printed or plain cardboard box. Transport cardboard boxes are always unprinted, in brown color. It's made from a stronger cardboard to sufficiently protect the antenna in transit from our warehouse to the customer. Transport cardboard box typically contains 5 or 10 antennas, depending on the product type and size.

Vse ISKRA antene so optimizirane za najboljši sprejem signalov na frekvenenem pasu za katerega so narejene. Večji del anten ima vgrajen »F« ženski konektor za lažjo montažo koaksialnega kabla na anteno.

Antene so izdelane iz aluminijeve zlitine EN AW 3005 (AlMn1Mg0,5) H165, ki ima visoko mehansko evrstost tudi v najbolj neugodnih vremenskih pogojih.

Vsi kovinski deli antene so iz vroče cinkanega jekla, ki je korozijsko odporen, plastične komponente pa so izdelane iz plastike, ki je UV obstojna. Njene lastnosti so v vseh vremenskih pogojih nespremenljive.

Antene so posamično pakirane v PVC vrečkah, nekatere imajo priloženo obešanko za lažje obešanje antene na obešalo. Antene so lahko tudi pakirane v nepotiskano ali potiskano posamično embalažo. Skupinska transportna embalaža je vedno nepotiskana, rjave barve. Izdelana iz močnejšega kartona, ki anteno dovolj zaščiti na poti od našega skladišča do kupca. V skupinski transportni embalaži je običajno 5 ali 10 anten.

Types/Tipi:

- Radio Antennas
Radijske antene
- LOG Antennas
LOG antene
- YAGI Antennas
YAGI antene
- Indoor Antennas
Sobne antene
- Professional Antennas
Profesionalne antene

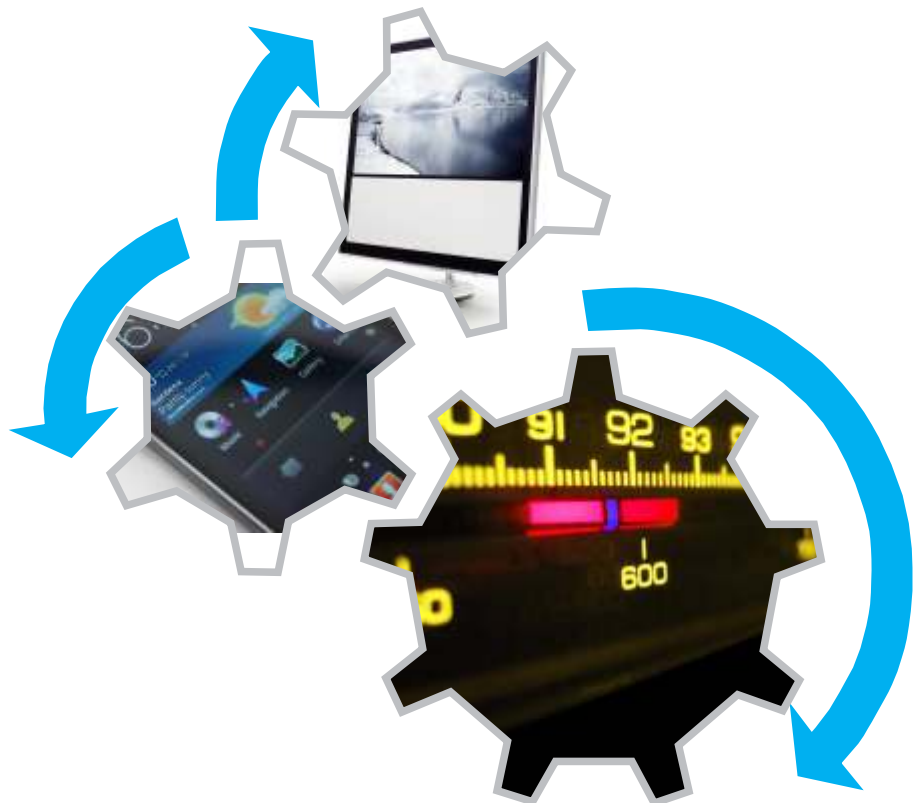

Radio Antennas Radijske antene

FM (87,5-108 MHz)
DAB (217-240 MHz)



FM-10F



FM-10VF



FM-30F



DAB-FM/F



DAB-3F

Impedance	75 Ohm	Polarization	Horiz./Vert.	Mounting on mast	D= 20-50 mm ... saddle 4 / sedlo 4 D= 20-62 mm ... saddle 5 / sedlo 5
Impedanca		Polarizacija		Montaža na drog	

D outside mast diameter / zunanji premer droga

Technical data / Tehnični podatki

Frequency Frekvenca	Type Tip	No. of elements Število elementov	Gain Dobitek	F/B ratio Razmerje naprej-nazaj	Beam width Širina glav. lista	Antenna carrier Nosilec	Length Dolžina antene	Packing Pakiranje		
								pcs. kom.	cm	m ³
FM	FM-10F	1	-0.8 dB(i)	-	Horiz. 360°	18 x 12 **	-	1	53 x 28 x 9	0.013
	FM-10VF	1	Horiz. -1 dB(i) Vert. -2 dB(i)	0 dB	Vert. 360°	18 x 12 **	-	10	111 x 34 x 27	0.102
	FM-30F	3	4.5 - 5.5 dB(i)	10 - 15 dB	Horiz. 70° Vert. 110°	18 x 12 **	116 cm	1	145 x 14 x 13	0.026
	FM-50F	5	6.5 - 7.5 dB(i)	18 - 24 dB	Horiz. 50° Vert. 70°	18 x 18 ***	176 cm	10	146 x 25 x 31	0.113
DAB*	DAB-FM/F	2	FM: -0.8 dB(i) DAB: 2.2 dB(i)	0 dB	FM: ±360° DAB: ±90°	18 x 18 ***	-	1	145 x 14 x 13	0.026
	DAB-1F	1	2.2 dB(i)	0 dB	360°	18 x 18 ***	25.5 cm	10	148 x 33.5 x 33	0.164
	DAB-3F	3	5 dB(i)	11 - 16 dB	Vert. 68°	18 x 18 ***	59 cm	10	80 x 31 x 23	0.057
	DAB-5F	5	8 dB(i)	19 - 26 dB	Vert. 65°	18 x 18 ***	110.5 cm	10	89 x 25 x 32	0.071

* DAB antennas are used for DAB (Digital Audio Broadcasting) signal reception / DAB antene so narejene za sprejem digitalnih radijskih signalov DAB (Digital Audio Broadcasting)

** Antenna has saddle 4, without inclination, only horizontal polarization / Antena ima sedlo 4, brez inklinacije, samo horizontalna polarizacija

*** Antenna has saddle 5, inclination 0-10°, horizontal or vertical polarization / Antena ima sedlo 5, inklinacija 0-10°, horizontalna ali vertikalna polarizacija

All antennas have "F" type female connector. / Vse antene imajo "F" ženski konektor.

Gain diagrams / Grafi dobitev

FM-10F FM-10VF

FM-30F FM-50F

DAB-3 DAB-5

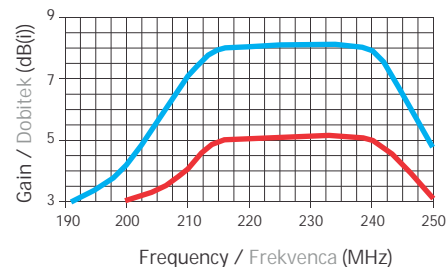
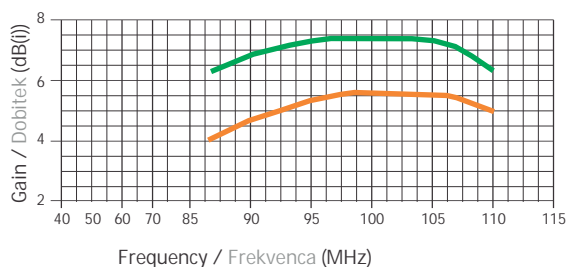
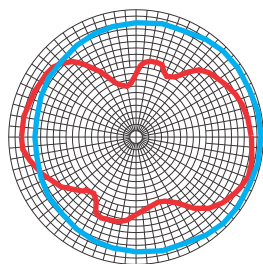

Description of different versions of LOG antennas

Opis različnih izvedb LOG anten

- 1 Antenna carriers / Nosilca antene
aluminium tube / aluminijasta cev
14x14x0.7 EN AW 3005 (AlMn1Mg0.5) H165
- 2 Iron parts / Kovinski deli
hot galvanized steel / vroče cinkano jeklo
- 3 Fixing to mast / Pritrditev antene na drog
"U" screw M6 / "U" vijak M6
outside mast diameter / zunanji premer droga
D = 20 ... 50 mm

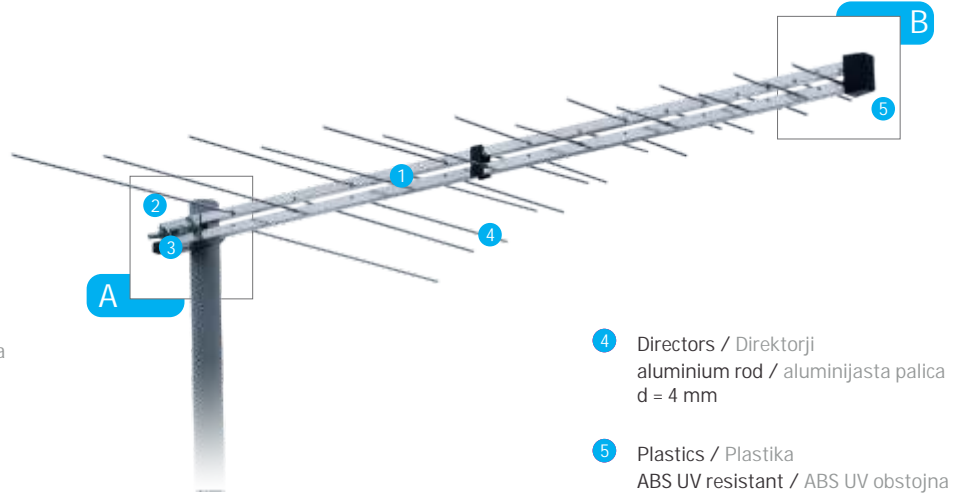

- 4 Directors / Direktorji
aluminium rod / aluminijasta palica
d = 4 mm
- 5 Plastics / Plastika
ABS UV resistant / ABS UV obstojna

Standard version for mounting on mast

Standardna izvedba za montažo na drog

The standard version allows mounting the antenna on the mast only in horizontal position (for horizontal polarisation) without inclination. Antenna can be mounted in vertical position (for vertical polarisation) with mounting accessory D2-V.(see page 43).

Standardna izvedba omogoča montažo antene na drog le v horizontalnem položaju (za horizontalno polarizacijo), brez inklinacije. Anteno lahko montirate na drog v vertikalnem položaju (za vertikalno polarizacijo) z uporabo dodatnega pribora D2-V.(glej stran 43).



H/V version for mounting on mast

H/V izvedba za montažo na drog

The H/V version allows mounting the antenna on the mast in horizontal position (for horizontal polarisation) or in vertical position (for vertical polarisation) without inclination.

Eg.: P-2845 F H/V

H/V izvedba omogoča montažo antene na drog v horizontalnem položaju (za horizontalno polarizacijo) ali v vertikalnem položaju (za vertikalno polarizacijo), brez inklinacije.

Npr. P-2845 F H/V

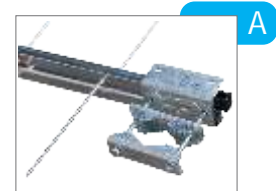

Version without "F" female connector

Izvedba brez "F" ženskega konektorja

The cable must be inserted into the bottom antenna carrier. Coaxial cable is connected to antenna mechanically by screws.
Eg: P-2845

Kabel je potrebno vstaviti v spodnji nosilec antene. Priklop kabla je mehanski, s pomočjo vijakov.
Npr. P-2845



A

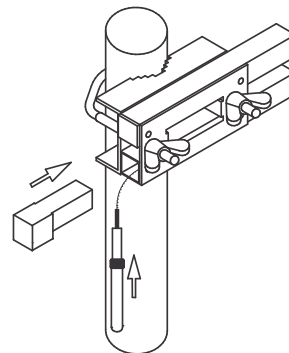

B

Version with built-in "F" female connector

Izvedba z vgrajenim "F" ženskim konektorjem

The antenna has a built-in "F" female connector. Coax. cable with "F" male connector must be connected to the antenna and protected by rubber protector (antenna already includes connector and rubber protector).

Antena ima vgrajen "F" ženski konektor. Kabel se s pomočjo "F" moškega konektorja priključi na anteno in zaščiti s protektorjem (konektor in protektor sta priložena).

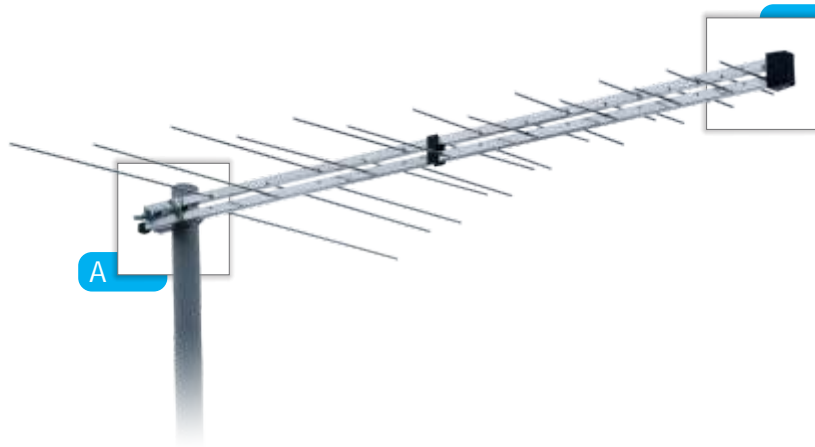

A

B

Version with fixed "F" female connector

Izvedba s fiksnim "F" ženskim konektorjem

Passive antenna without amplifier.

Pasivna antena brez ojačevalnika.

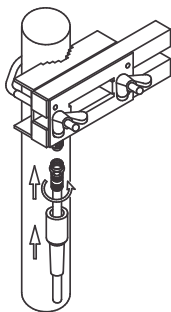

Active antenna with amplifier.

Aktivna antena z ojačevalnikom.

Active antenna can have built-in following amplifiers inside the antenna carrier:

- low noise amplifier DIGI-LOG 14VU (see page 13) Eg.: P-2845 **DTT/G**
- low noise amplifier DIGI-LOG 15R-U (with SWITCH system) (see page 13) Eg.: P-2845 **G-SWITCH**
- low noise amplifier DIGI-LOG 14VU with LTE CUT filter LTE 800 LIGHT (see page 13) Eg.: P-2845 **GLT**

Suitable power supply unit with output DC12V, 150 mA

Aktivna antena ima lahko v nosilcu antene vgrajena sledeča ojačevalnika:

- nizkošumni ojačevalnik DIGI-LOG 14VU (glej stran 13) Npr.: P-2845 **DTT/G**
- nizkošumni ojačevalnik DIGI-LOG 15R-U (s SWITCH sistemom) (glej stran 13) Npr.: P-2845 **G-SWITCH**
- nizkošumni ojačevalnik DIGI-LOG 14VU z vgrajenim LTE sesalnim filtrom LTE 800 LIGHT (glej stran 13) Npr.: P-2845 **GLT**

Primeren napajalnik je z izhodom izm. 12V, 150 mA

Passive antenna can have following built-in inside the antenna carrier:

- only F female connector Eg.: P-20 **F**
- F female connector with LTE CUT filter (see page 27)
 - LTE 800 LIGHT filter Eg.: P-20 **FLT**
 - LTE 800 HQ BASIC filter Eg.: P-20 **FL**
 - LTE 700/800 LIGHT filter Eg.: P-20 **FLT7**
 - LTE 700/800 HQ BASIC filter Eg.: P-20 **FL7**

Pasivna antena ima v nosilcu antene vgrajen:

- samo F ženski konektor Npr.: P-20 **F**
- F ženski konektor z LTE sesalnim filtrom (glej stran 27)
 - LTE 800 LIGHT filter Npr.: P-20 **FLT**
 - LTE 800 HQ BASIC filter Npr.: P-20 **FL**
 - LTE 700/800 LIGHT filter Npr.: P-20 **FLT7**
 - LTE 700/800 HQ BASIC filter Npr.: P-20 **FL7**



Version with rotating "F" female connector

Izvedba z vrtljivim "F" ženskim konektorjem

In this version it is possible to turn "F" connector for 90° very easy. With this version it is suitable to use antenna in vertical polarization. It is used only for passive antennas without built-in LTE filters. Eg.: P-2845 **FZ**

V tej izvedbi je mogoče zavrteti "F" konektor za 90°. Ta izvedba je še posebej primerna za uporabo antene tudi v vertikalni polarizaciji. Uporablja se le pri pasivnih antenah brez vgrajenega LTE filtra. Npr.: P-2845 **FZ**

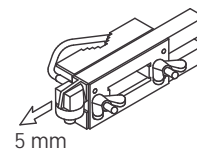
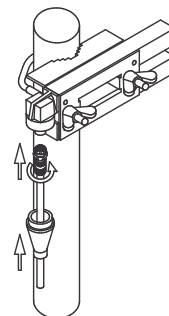
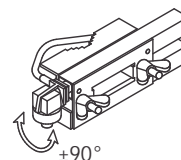

LOG Antennas - VHF

LOG antene - VHF

VHF
Ch. 5-12 (174-230 MHz)

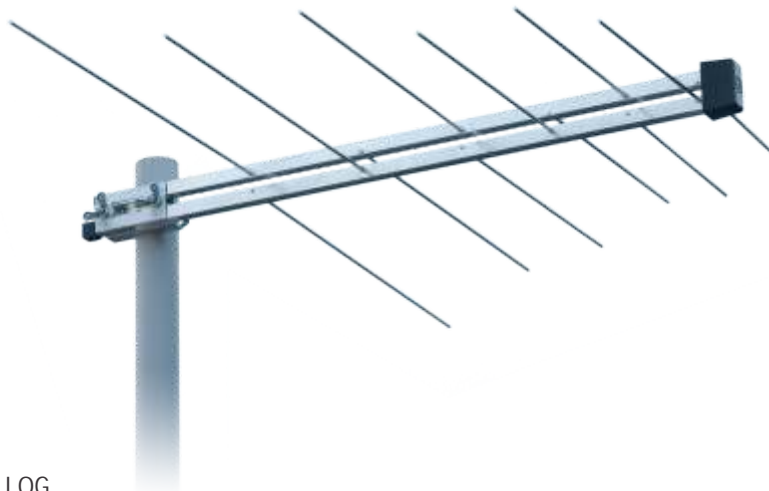

VF-12 LOG

Technical data / Tehnični podatki											
Type Tip	No. of elements Število elementov	Gain Dobitek	F/B ratio Razmerje naprej-nazaj	Beam width Širina glav. lista	Connection Prikljueek	Impedance Impedanca	Lenght Dolžina antene	Packing Pakiranje			
								pcs. kom.	cm	m ³	
VF-12 LOG	12	7.5 - 8.5 dB(i)	20 dB	Horiz. 50° Vert. 60°	-	75 Ohm	69 cm	5	90 x 70 x 17	0.107	
VF-12 LOG F*					"F"			10	90 x 79 x 17	0.121	
VF-16 LOG	16	10 dB(i)	22 dB	Horiz. 45° Vert. 55°	-		75 Ohm	121 cm	1	122 x 87 x 7	0.074
VF-16 LOG F*					"F"				10	157 x 89 x 17	0.262

* Passive antenna with different connections (see page 4) / Pasivna antena z različnimi priklopi (glej stran 4)

Gain diagram / Graf dobitkov

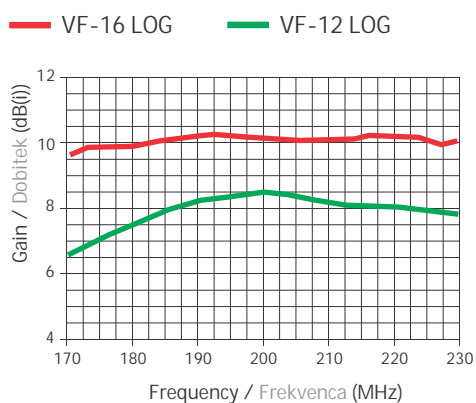

UHF
Ch. 21-69 (470-862 MHz)



P-20



P-20 WF



P-28

Technical data / Tehnični podatki

Type Tip	Channels (frequency) Kanali (frekvenca)	No. of elements Število elementov	Gain Dobitek	F/B ratio Razmerje naprej-nazaj	Beam width Širina glav. lista	Connection Priključek	Impedance Impedanca	Length Dolžina antene	Packing Pakiranje		
									pcs. kom	cm	m ³
P-16 P-16 F*	Ch. 57 - 69 (758 - 862 MHz)	16	8 dB(i)	18 dB	Horiz. 48 - 54° Vert. 52 - 60°	-	75 Ohm	55 cm	5	59 x 27 x 18	0.029
P-16 DTT/G**			22 dB(i)			"F"					
P-18 P-18 F*	Ch. 21 - 69 (470 - 862 MHz)	18	8 dB(i)	20 dB	Horiz. 47 - 53° Vert. 50 - 58°	-		60 cm	10	111 x 34 x 16	0.060
P-18 DTT/G**			23 dB(i)			"F"					
P-20 P-20 F* P-20 WF*	Ch. 21 - 69 (470 - 862 MHz)	20	7.5 dB(i)	21 dB	Horiz. 49 - 56° Vert. 53 - 60°	-		40 cm	25	111 x 34 x 27	0.102
P-20 DTT/G**			22.5 dB(i)			"F"		40 cm			
P-20 W DTT/G**						"F"		44 cm			
						"F"		44 cm			
P-2404 P-2404 F* P-2404 DTT/G**	Ch. 21 - 37 (470 - 606 MHz)	24	11 dB(i)	>27 dB	Horiz. 39 - 48° Vert. 42 - 51°	-		116 cm	9	148 x 33.5 x 33	0.164
			26 dB(i)			"F"					
P-28 P-28 F* P-28 DTT/G**	Ch. 21 - 69 (470 - 862 MHz)	28	8 dB(i)	23 dB	Horiz. 43 - 50° Vert. 48 - 52°	-		77 cm	5	81 x 36 x 17	0.050
			23 dB(i)			"F"					
						"F"					

* Passive antenna with different connections (see page 4) / Pasivna antena z različnimi prikljuki (glej stran 4)

** Active antenna with built-in low noise amplifier (see page 13) / Aktivna antena z vgrajenim nizkošumnim ojačevalnikom (glej stran 13)

Gain diagram / Graf dobitkov

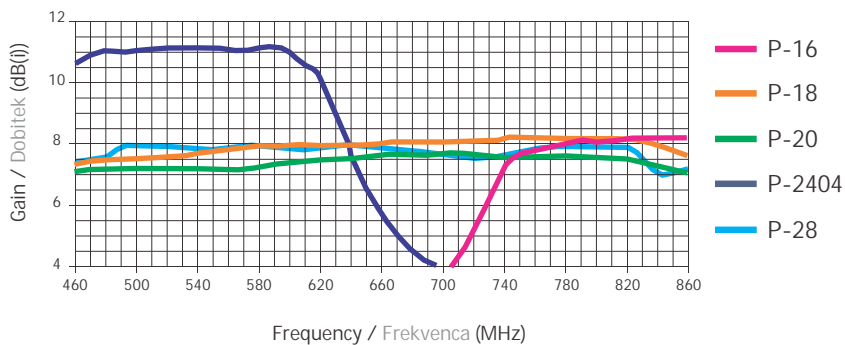

LOG Antennas - UHF

LOG antene - UHF

Mounting antenna on window's frame

Pritrditev antene na okenski okvir

Special types are P-20 WF and P-20 W DTT/G. They contain additional carrier for mounting antenna on window's frame, for horizontal or vertical polarisation.

Posebna izvedba sta anteni P-20 W in P-20 W DTT/G, ki imata zgornji nosilec daljši. Priložen je dodatni nosilec 18x12, ki omogoča pritrditev antene na okenski okvir za horizontalno ali vertikalno polarizacijo.

P-20 WF
P-20 W DTT/G



For horizontal polarization / za horizontalno polarizacijo



For vertical polarization / za vertikalno polarizacijo

P-20 W DTT/G kit / P-20 W DTT/G komplet



Antenna
Antena
P-20 W DTT/G



Coax. cable extension
Koaksialni podaljšek
L = 10 m



Power supply
Napajalnik



Polybag with hanging carton
Vrečka z obešanko

UHF
Ch. 21-69 (470-862 MHz)



P-2845



P-5045

Technical data / Tehni?ni podatki

Type Tip	Channels (frequency) Kanali (frekvenca)	No. of elements Število elementov	Gain Dobitek	F/B ratio Razmerje naprej-nazaj	Beam width Širina glav. lista	Connection Prikljueek	Impedance Impedanca	Lenght Dolžina antene	Packing Pakiranje		
									pcs. kom.	cm	m ³
P-2845 P-2845 F*	Ch. 21 - 69 (470 - 862 MHz)	28	9.5 dB(i)	24 dB	Horiz. 35 - 45° Vert. 55 - 46°	-	75 Ohm	106 cm	1	106 x 34.5 x 5.5	0.020
P-2485 DTT/G **			5						111 x 34 x 16	0.060	
			10						111 x 34 x 27	0.102	
P-2845 N P-2845 NF*	Ch. 21 - 69 (470 - 862 MHz)	28	10 dB(i)	27 dB	Horiz. 30 - 40° Vert. 52 - 43°	-	75 Ohm	114 cm	10	121 x 34 x 27	0.111
P-2845 N DTT/G **											
P-3405 P-3405 F*	Ch. 38 - 69 (606 - 862 MHz)	34	12 dB(i)	>27 dB	Horiz. 44° Vert. 46°	-	75 Ohm	127 cm	15	144 x 33.5 x 30	0.145
P-3405 DTT/G **											
P-5045 P-5045 F*	Ch. 21 - 69 (470 - 862 MHz)	50	12-12.5 dB(i)	26 dB	Horiz. 26° Vert. 42°	-	75 Ohm	205 cm	2	206 x 33 x 9	0.061
P-5045 DTT/G **			5						111 x 34 x 27	0.102	

* Passive antenna with different connections (see page 4) /

Pasivna antena z različnimi priklopi (glej stran 4)

** Active antenna with built-in low noise amplifier (see page 13) /

Aktivna antena z vgrajenim nizkošumnim ojaevalnikom (glej stran 13)

Antennas P-5045 and P-5045 DTT/G are used only for horizontal polarization due to construction limitation.

Anteni P-5045 in P-5045 DTT/G se uporabljata le za horizontalno polarizacijo zaradi konstrukcijskih omejitev.

Gain diagram / Graf dobitkov

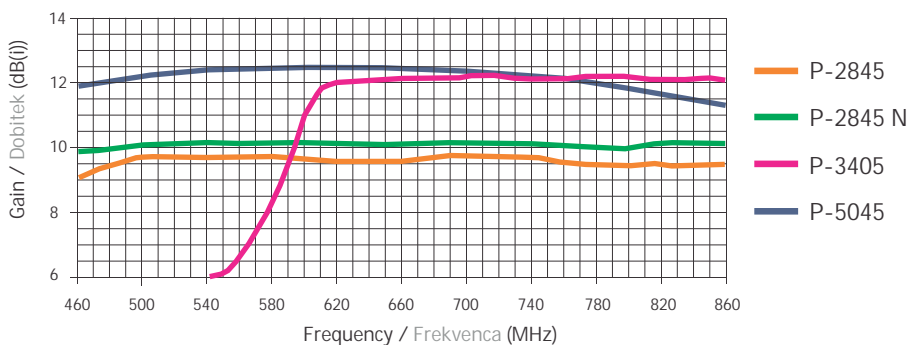

P-2845 DTT/G kit / P-2845 DTT/G komplet



Antenna
Antena
P-2845 DTT/G

+

Coax. cable extension
Koaksialni podaljšek
L = 10 m

+



Power supply
Napajalnik

+

Polybag with hanging carton
Vrečka z obešanko

LOG Antennas - VHF/UHF

LOG antene - VHF/UHF

VHF + UHF

Ch. 5-12 (174 - 230 MHz)

Ch. 21-69 (470 - 862 MHz)



P-3235 MINI

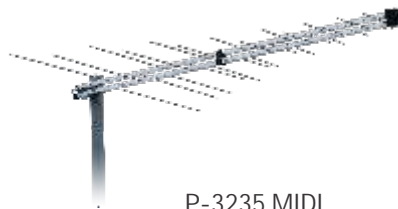

P-3235 MIDI

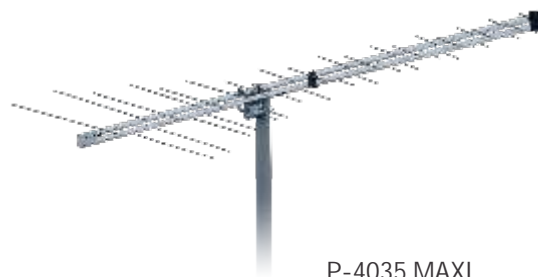

P-4035 MAXI

Technical data / Tehni?ni podatki

Type Tip	Channels (frequency) Kanali (frekvenca)	No. of elements Število elementov	Gain Dobitek	F/B ratio Razmerje naprej-nazaj	Beam width Sirina glav. lista	Connection Prijkljueek	Impedance Impedanca	Lenght Dolžina antene	Packing Pakiranje		
									pcs. kom	cm	m ³
P-2434 P-2434 F*	Ch. 5 - 12 (174 - 230 MHz)	24	Ch.5-12: 8 dB(i) Ch.21-37: 9 dB(i)	20-24 dB	Horiz. 46 - 57° Vert. 54 - 66°	-	75 Ohm	105.5 cm	10	117.5 x 99 x 17	0.200
P-2434 DTT/G**	Ch. 21 - 37 (470 - 606 MHz)		24 dB(i)			"F"					
P-3235 MINI P-3235 MINI F*	Ch. 5 - 12 (174 - 230 MHz)	32	7.5 dB(i)	18-22 dB	Horiz. 45 - 55° Vert. 55 - 65°	-					
P-3235 MINI DTT/G**	Ch. 21 - 69 (470 - 862 MHz)		22.5 dB(i)			"F"					
P-3235 MIDI P-3235 MIDI F*	Ch. 5 - 12 (174 - 230 MHz)		32			7.5-8.5 dB(i)		20-26 dB	Horiz. 45 - 55° Vert. 55 - 65°	"F"	
P-3235 MIDI DTT/G**	Ch. 21 - 69 (470 - 862 MHz)	23 dB(i)		"F"							
P-4035 MAXI P-4035 MAXI F*	Ch. 5 - 12 (174 - 230 MHz)	40	VHF: 7.5-8.5 dB(i) UHF: 10-12 dB(i)	22-28 dB	Horiz. 35 - 45° Vert. 30 - 55°	-					
P-4035 MAXI DTT/G**	Ch. 21 - 69 (470 - 862 MHz)		VHF: 22 dB(i) UHF: 26 dB(i)			"F"					
						"F"					

* Passive antenna with different connections (see page 4) /
Pasivna antena z različnimi prikljopi (glej stran 4)

** Active antenna with built-in low noise amplifier (see page 13) /
Aktivna antena z vgrajenim nizkošumnim ojaevalnikom (glej stran 13)

The antennas P-4035 MAXI F and P-4035 MAXI DTT/G are used only for horizontal polarization due to construction limitation.

Anteni P-4035 MAXI F in P-4035 MAXI DTT/G se uporabljata le za horizontalno polarizacijo zaradi konstrukcijskih omejitev.

Gain diagrams / Grafi dobitekov

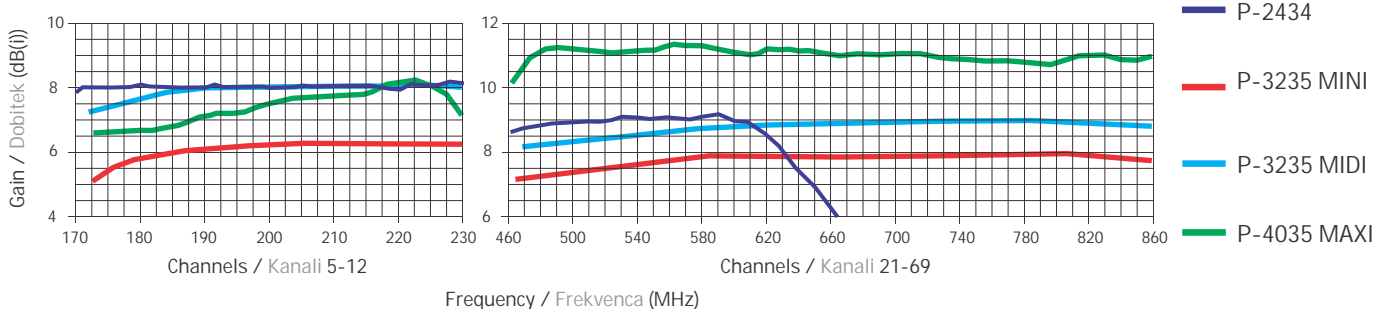

G-3235 ME-N kit / G-3235 ME-N komplet

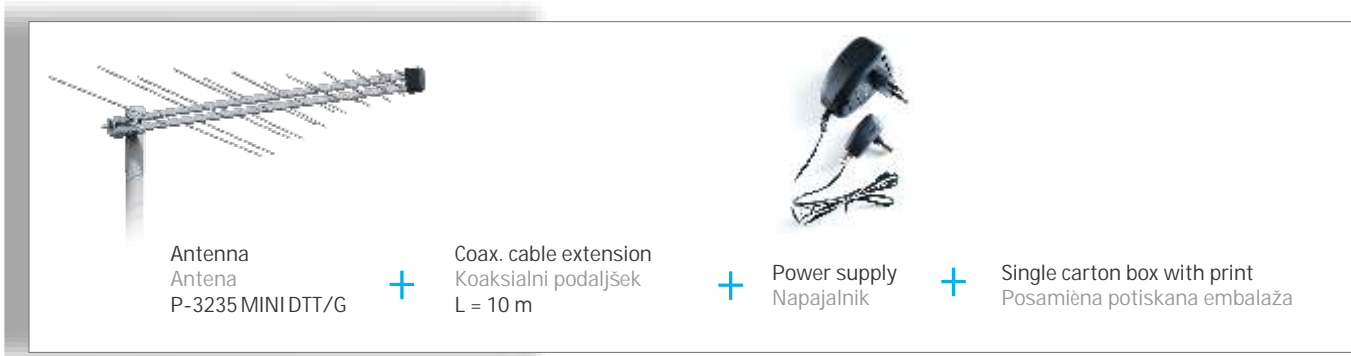

Examples of connection G-3235 ME-N

Primer priključitve G-3235 ME-N

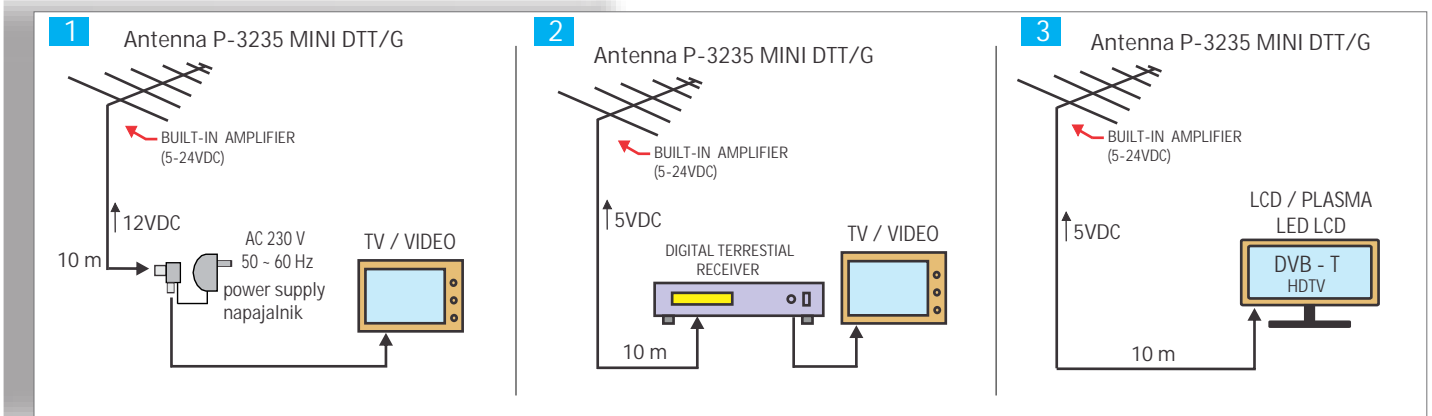

Built-in Antenna Amplifiers for LOG Antennas

Vgrajeni antenski ojaèevalniki za LOG antene

Low-noise antenna amplifier serie DIGI-LOG is built-in inside the aluminium antenna carrier 14x14. It is used only for LOG antennas. Amplifier can be supplied from outside power supply* or directly from DVB-T receiver. Power supply is provided through the same coax. cable as reception signal.

Nizkošumni antenski ojaèevalnik serije DIGI-LOG je vgrajen v notranjosti aluminijastega nosilca 14x14. Uporablja se le pri LOG antenah. Napaja se iz zunanjega napajalnika* ali direktno iz digitalnega zemeljskega sprejemnika. Napajanje poteka preko istega koaks. kabla kot je prenos signala iz antene k TV.

Technical data / Tehnični podatki					
Amplifier type Tip ojaèevalnika	Frequency range Frekveneni pas	Amplification Ojaèanje	Noise figure Šumno št.	Power supply Napajanje	Impedance / Connector Impedanca / konektor
DIGI-LOG 14VU ¹⁾	Ch. 5 - 69 174 - 862 MHz	16 dB @ 5-24 VDC	2 dB	25 mA @ 5-24 VDC	75 Ohm "F" female "F" ženski
DIGI-LOG 14VU + LTE filter LTE 800 LIGHT ^{1) 3)}	Ch. 5 - 60 174 - 790 MHz				
DIGI-LOG 15R-U ²⁾	Ch. 21 - 69 470 - 862 MHz	15 dB @ 5-24 VDC	83 mA @ 5-24 VDC		

* Recommended power supply with output DC12V, 150 mA / Priporoèamo napajalnik z izhodom izm. 12V, 150 mA.

1) Antenna is receiving signals only if the amplifier is power supplied (by power supply or by DVB-T receiver)/

Antena sprejema signale samo èe je ojaèevalnik napajan z elektrièno energijo (iz napajalnika ali iz DVB-T sprejemnika)

2) Antenna amplifier DIGI-LOG 15R-U has built-in SWITCH system and 4 NOTCH (stop band) filters for TETRA 400 and GSM 900 MHz frequencies /

Antenski pjaèevalnik DIGI-LOG 15R-U ima vgrajen switch sistem in 4 sesalne filtre proti motnjam od TETRA 400 in GSM 900 MHz frekvenc

3) This antenna amplifier has built-in LTE CUT filter LTE 800 LIGHT for cutting LTE 800 frequencies 791-862 MHz (see page 27).

Ta antenski pjaèevalnik ima vgrajen LTE sesalni filter LTE 800 LIGHT za dušenje LTE 800 signalov 791-862 MHz (glej stran 27).

Diagram of amplification / Graf ojaèanja

DIGI-LOG 15R-U

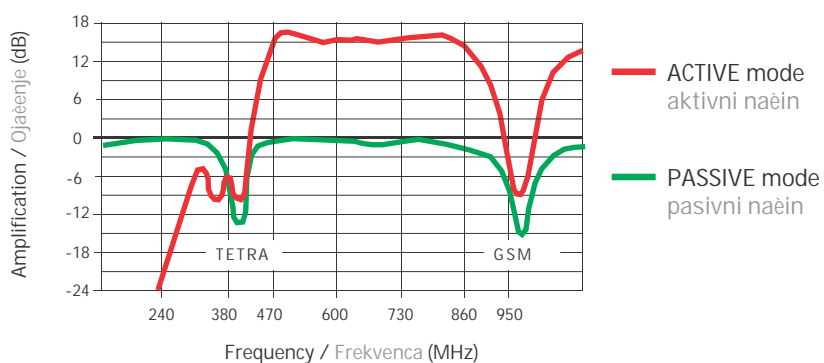

How "SWITCH" system works:

Kako deluje sistem "SWITCH":

Example: Antenna P-20 G-SWITCH

1. LOW UHF signal:
Switch ON power supply (5-24 VDC)
Gain = Antena + amplifier = 22.5 dB(i)
2. Strong UHF signal
Switch OFF power supply (don't need it)
Gain = Gain of antenna = 7.5 dB(i)

Primer: Antena P-20 G-SWITCH

1. Šibek UHF signal:
Vkljopimo (ON) napajanje (enosm. 5-24 V)
Ojaèenje = Antena + ojaèevalnik = 22,5 dB(i)
2. Moèan UHF signal
Izklopimo (OFF) napajanje (napajanja ne potrebujemo)
Ojaèenje = dobitok antene = 7,5 dB(i)

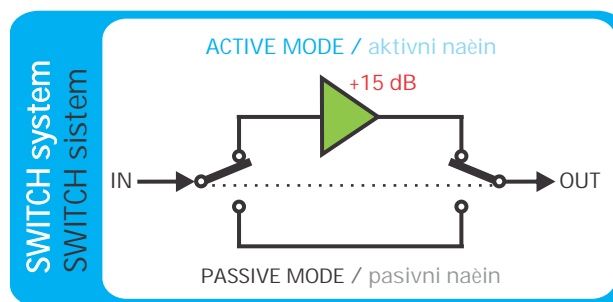

Examples of connection / Primeri prikljuèitve

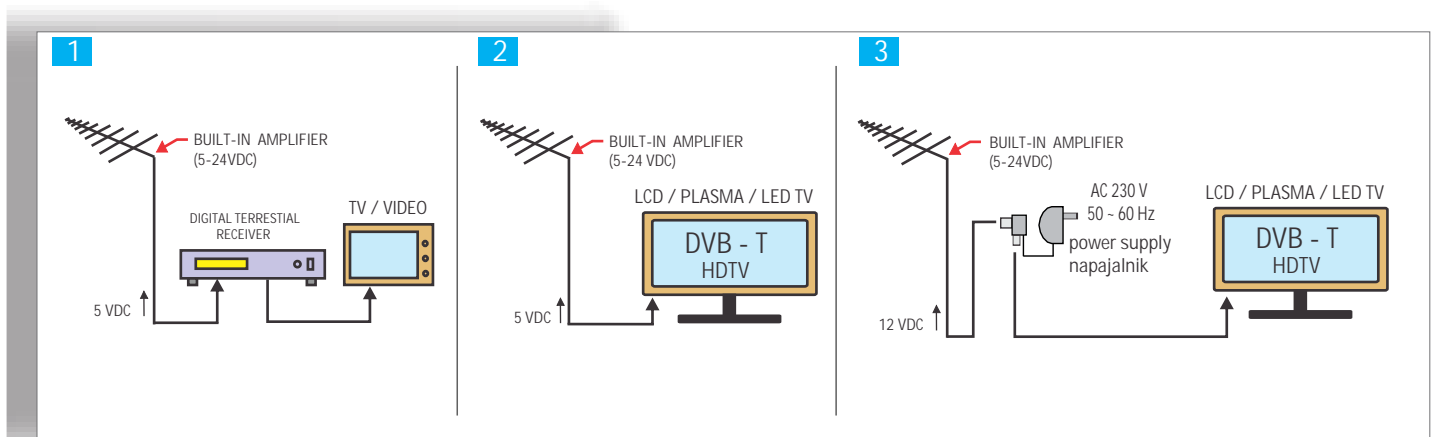

Description of different versions of YAGI antennas

Opis različnih izvedb YAGI anten

1 Antenna carriers / Nosilca antene
aluminium tube / aluminijasta cev
18x12x0.7 EN AW 3005 (AlMn1Mg0.5) H165

2 Antenna carriers / Nosilca antene
aluminium tube / aluminijasta cev
18x18x0.7 EN AW 3005 (AlMn1Mg0.5) H165

3 Iron parts / Kovinski deli
hot galvanized steel / vroče cinkano jeklo

4 Fixing to mast / Pritrditev antene na drog
Inclination 0-10°, horizontal or vertical polarization /
inklinacija 0-10°, horizontalna ali vertikalna polarizacija
outside mast diameter / zunanji premer droga
D = 20... 62 mm

5 Plastics / Plastika
ABS UV resistant / ABS UV obstojna

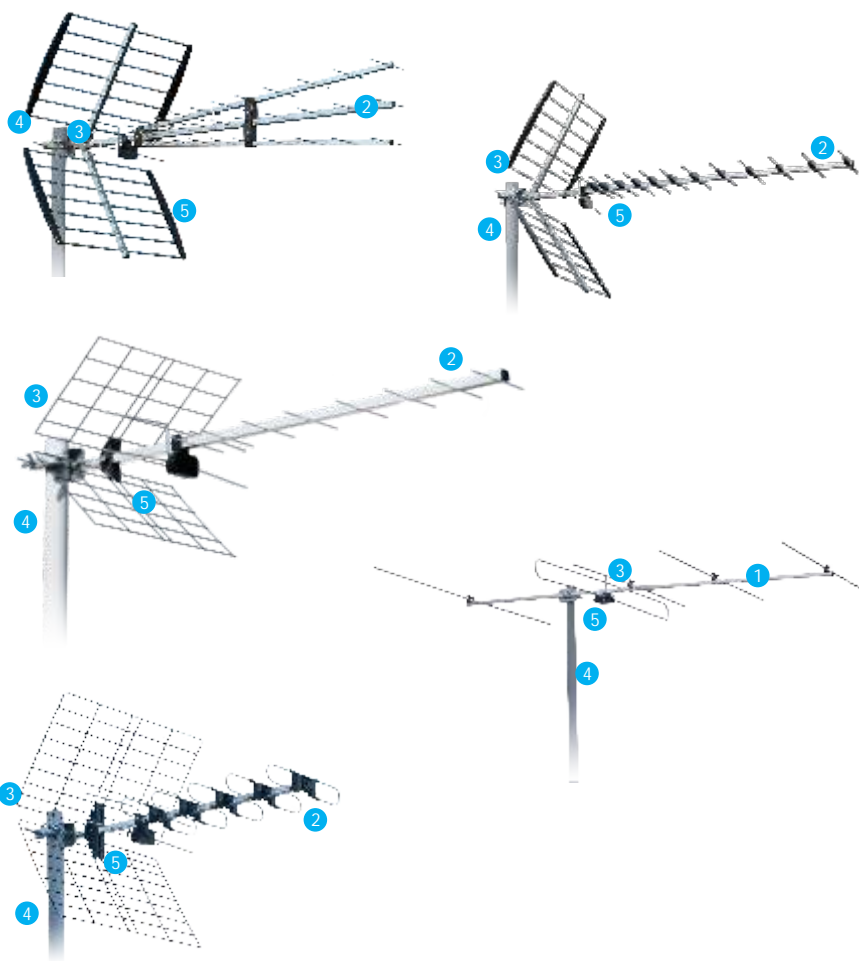

Reflectors / Reflektorji

All reflectors are already factory-assembled. Each antenna's reflector is adjusted to achieve the best possible characteristics for the antenna. Reflector's installation on the antenna carrier is quick and easy without additional tools.

Vsi reflektorji so že tovarniško sestavljeni. Za vsako anteno so prilagojeni, da ima antena čimboljše lastnosti. Montaža na nosilec antene je hitra in enostavna brez dodatnega orodja.

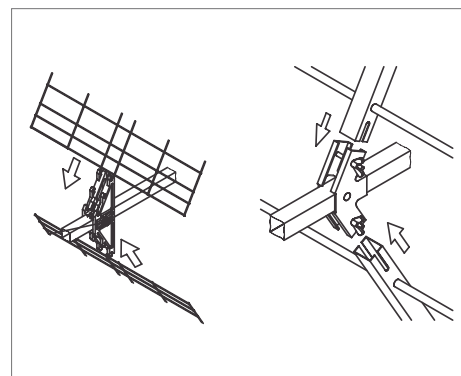

Dipole / Dipol

Dipole is the heart of antenna. Therefore, each dipole of ISKRA antenna is designed for the best signal reception on its frequency band. YAGI antennas have mechanically 3 different dipoles:

- Classic dipole (direct connection of coax. cable or with "F" female connector)
- DTX "F" dipole (with "F" female connector only)

DTX "F" dipole can have following baluns inside:

- passive dipole for channels 21-69
- passive dipole with LTE 800 LIGHT filter (for channels 21-60) (see page 27)
- passive dipole with LTE 800 HQ BASIC filter (for channels 21-60) (see page 27)
- passive dipole with LTE 800 HQ PLUS filter (for channels 21-60) (see page 27)
- passive dipole with LTE 700/800 LIGHT filter (for channels 21-48) (see page 27)
- passive dipole with LTE 700/800 HQ BASIC filter (for channels 21-48) (see page 27)
- active dipole with built-in amplifier DIGI-YAGI 16U (see page 25)
- active dipole with built-in amplifier DIGI-YAGI 18-U (see page 25)
- active dipole with built-in amplifier DIGI-YAGI 18-U and LTE CUT filter LTE 800 LIGHT (see page 25)

Dipol je srce antene, zato ima vsaka ISKRA antena dipol natančno prilagojen za najboljši sprejem signalov v svojem frekvenenem pasu. YAGI antene imajo mehansko 3 različne dipole:

- Klasični dipol (direkten priklop koaksialnega kabla ali z "F" ženskim konektorjem)
- DTX "F" dipol (le z "F" ženskim konektorjem)

DTX "F" dipol lahko vsebuje različne simetrične elemente:

- pasivni dipol za kanale 21-69
- pasivni dipol z LTE 800 LIGHT filtrom (za kanale 21-60) (glej stran 27)
- pasivni dipol z LTE 800 HQ BASIC filtrom (za kanale 21-60) (glej stran 27)
- pasivni dipol z LTE 800 HQ PLUS filtrom (za kanale 21-60) (glej stran 27)
- pasivni dipol z LTE 700/800 LIGHT filtrom (za kanale 21-48) (glej stran 27)
- pasivni dipol z LTE 700/800 HQ BASIC filtrom (za kanale 21-48) (glej stran 27)
- aktivni dipol z ojačevalnikom DIGI-YAGI 16U (glej stran 25)
- aktivni dipol z ojačevalnikom DIGI-YAGI 18-U (glej stran 25)
- aktivni dipol z ojačevalnikom DIGI-YAGI 18-U in LTE sesalnim filtrom LTE 800 LIGHT (glej stran 25)

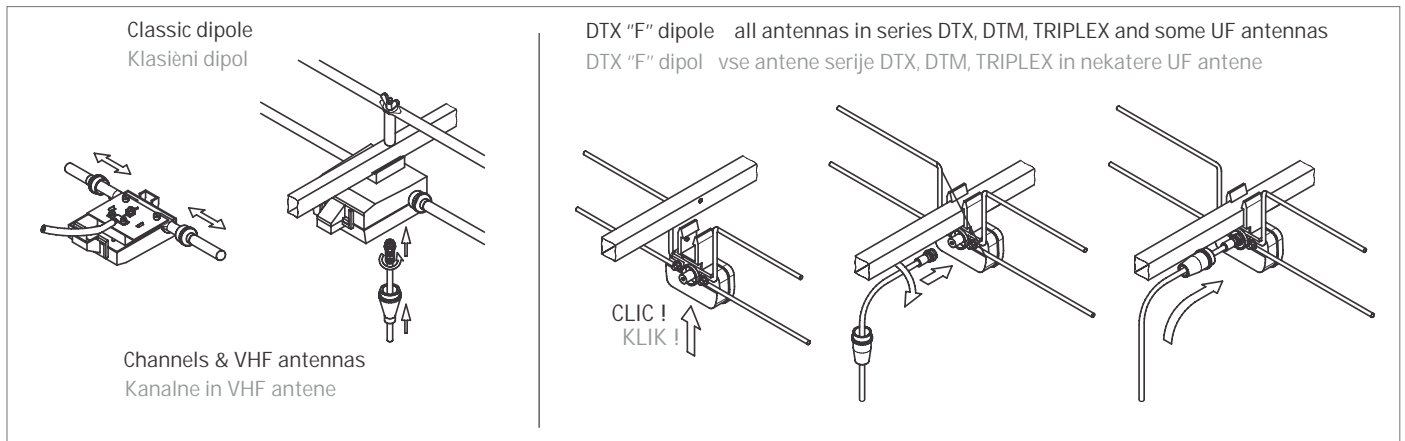

Directors / Direktorji

Directors have different shapes, dimensions and are electrically specially designed for each antenna type:

- Channel and VHF antennas tubes dia. 10 mm, premounted, final mounting without any tools
- DTX series antennas rods dia. 4 mm, final mounting without any tools
- DTM series antennas tubes dia. 8 mm, fixed on antenna carrier, additional mounting is not necessary
- TRIPLEX and UF series antennas rods dia. 4 mm, fixed on antenna carrier, additional mounting is not necessary

Direktorji so različnih izvedb, dimenzijsko in električno prilagojeni posameznemu tipu anten:

- Kanalne in VHF antene cevke f 10 mm, predmontirani, končno sestavljanje brez orodja
- Antene serije DTX palice f 4 mm, fkončno sestavljanje brez dodatnega orodja
- Antene serije DTM cevke f 8 mm, fiksne na nosilcu, dodatna montaža ni potrebna
- Antene TRIPLEX in UF palice f 4 mm, fiksne na nosilcu, dodatna montaža ni potrebna

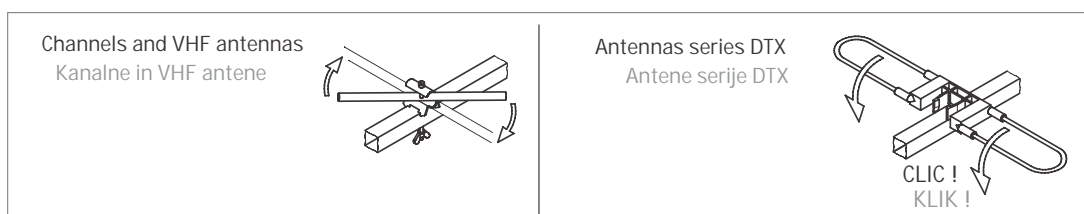

YAGI Antennas - Channel Antennas

YAGI antene - kanalne



B-3B



VF-6 FD

Impedance	75 Ohm	Polarization	Horiz./Vert.	Mounting on mast	D = 20 - 62 mm	outside mast diameter
Impedanca		Polarizacija		Montaža na drog		zunanj premer droga

Technical data / Tehnični podatki										
Type Tip	Channels (frequency) Kanal (frekvenca)	No. of elements Število elementov	Gain Dobitek	F/B ratio Razmerje naprej-nazaj	Beam width Sirina glav. lista	Antena carrier Nosilec antene	Lenght Dolžina antene	Packing Pakiranje		
								pcs. kom.	cm	m ³
VK-3 K3	Ch. 3 (54 - 61 MHz)	3	5.5 dB(i)	15 dB	Horiz. 60° Vert. 105°	18 x 18	187 cm	10	144 x 33.5 x 40.5	0.195
B-4 B*	Ch. B (61 - 68 MHz)	4	7.5 dB(i)	18 dB	Horiz. 58° Vert. 98°	18 x 18	121 cm	10	144 x 33.5 x 40.5	0.195
VF-6 FD*	Ch. D (174 - 181 MHz)	6	10 dB(i)	22 dB	Horiz. 56° Vert. 92°	18 x 12	174 cm	15	176 x 34 x 31	0.185
VF-6 FG*	Ch. G (200 - 207 MHz)	6	10 dB(i)	22 dB	Horiz. 54° Vert. 78°	18 x 12	131 cm	10	161 x 25 x 24	0.097

* Antenna with "F" female connector / antena z "F" ženskim konektorjem

We are producing also following channel antennas:

Proizvajamo tudi sledeče kanalne antene:

- VF-2 A
- B-2 B
- F-6 FE
- VF-2 R2
- B-3 A
- F-6 FF
- VF-2 K4
- B-3 B
- F-6 FH
- VF-3 K1-3
- B-3 C
- VF-3 K4
- B-4 A

Gain diagrams / Grafi dobitekov

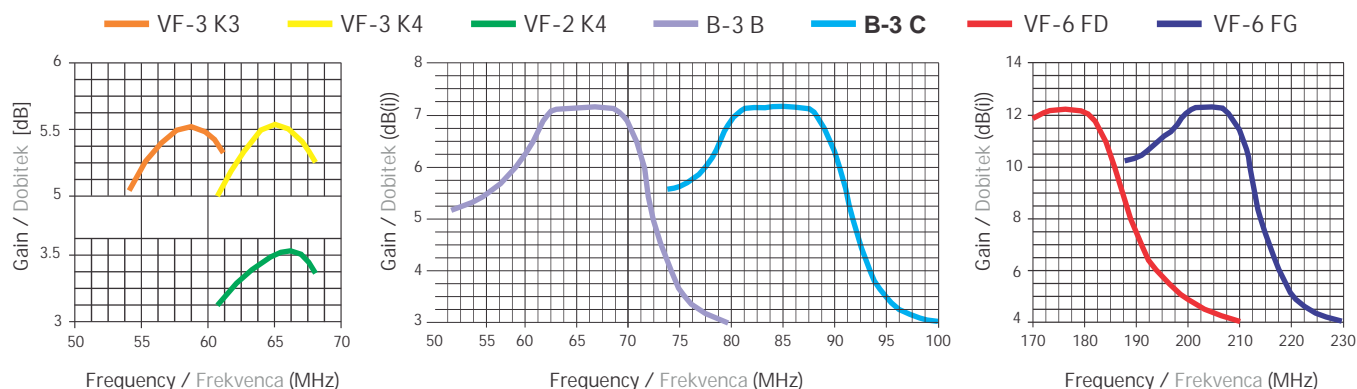

VHF
Ch. 5-12 (174-230 MHz)



VF-6 F



VF-9 F

Impedance	75 Ohm	Channels	5-12	Polarization	Horiz./Vert.	Antenna carrier	18 x 12	Mounting on mast	D = 20 - 62 mm
Impedanca		Kanali	(174-230 MHz)	Polarizacija		Nosilec antene		Montaža na drog	

D outside mast diameter / zunanji premer droga

Technical data / Tehnični podatki

Type Tip	No. of elements Število elementov	Gain Dobitek	F/B ratio Razmerje naprej-nazaj	Beam width Širina glav. lista	Length Dolžina antene	Packing Pakiranje		
						pcs. kom	cm	m ³
VF-4 VF-4F*	4	5 - 6 dB(i)	15 - 18 dB	Horiz. 60° Vert. 105°	67 cm	10	111 x 23 x 27	0.069
VF-6 VF-6F*	6	6 - 7.5 dB(i)	16 - 18 dB	Horiz. 58° Vert. 86°	122 cm	1	133 x 14 x 13.5	0.025
						10	161 x 25 x 24	0.097
VF-9 VF-9F**	9	7 - 10 dB(i)	17 - 22 dB	Horiz. 50° Vert. 72°	154 cm	1	164 x 14 x 13.5	0.031
						10	164 x 25 x 31	0.127
VF-13 VF-13F**	13	9 - 11.5 dB(i)	20 - 26 dB	Horiz. 46° Vert. 60°	208 cm	10	144 x 33.5 x 30	0.145

* Antenna with "F" female connector / antena z "F" ženskim konektorjem

** Antenna with "F" female connector. It is also possible to order antenna with antenna carrier 18x18. / Antena z "F" ženskim konektorjem. Možno je naročiti anteno z nosilcem antene 18x18.

Gain diagrams / Grafi dobitkov

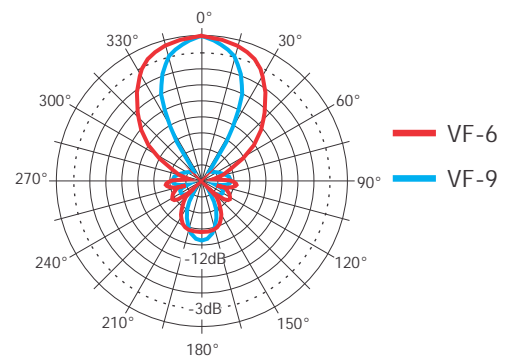
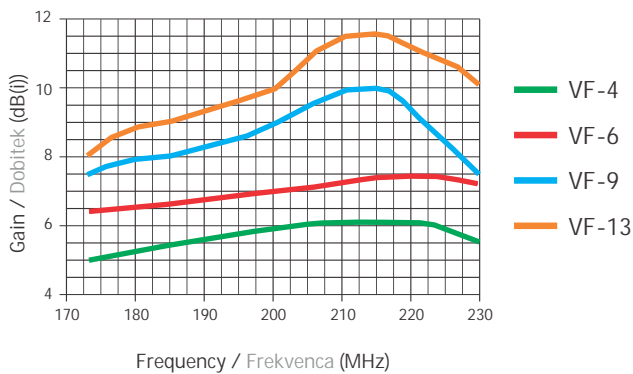

YAGI Antennas - series DTX

YAGI antene - serija DTX

UHF
Ch. 21-69 (470-862 MHz)

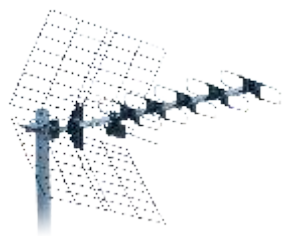

DTX-22 F



DTX-48 FC



DTX-92 FC

Impedance	75 Ohm	Dipole	DTX	Polarization	Horiz./Vert.	Antenna carrier	18 x 18	Mounting on mast	D = 20 - 62 mm
Impedanca		Dipol	"F"	Polarizacija		Nosilec antene		Montaža na drog	

D outside mast diameter / zunanji premer droga

Technical data / Tehnični podatki

Type Tip	Channels (frequency) Kanali (frekvenca)	No. of elements Število elementov	Gain Dobitek	F/B ratio Razmerje naprej-nazaj	Beam width Širina glav. lista	Reflector Reflektor	Length Dolžina antene	Packing Pakiranje		
								pcs. kom	cm	m ³
DTX-22 F	B.IV-V 21-69 (470-862 MHz)	22	10 - 14 dB(i)	>28 dB	Horiz. 62-32°	Type 1 Tip 1	81 cm	10	88 x 37 x 29	0.094
DTX-22 FC						Type 2 Tip 2		10	96 x 41 x 54	0.210
DTX-48 F	B.IV-V 21-37 (470-606 MHz)	48	11- 16 dB(i)	>29 dB	Horiz. 54-26°	Type 1 Tip 1	111 cm	10	117 x 37x 29	0.126
DTX-48 FC						Type 2 Tip 2		10	116 x 41 x 40	0.190
DTX-48 F 4	B.IV-V 21-37 (470-606 MHz)	48	12 - 13 dB(i)	>27 dB	Horiz. 54-40°	Type 1 Tip 1	120 cm	10	126 x 37 x 29	0.135
DTX-48 F 5	B.V 38-69 (606-862 MHz)		13 - 16 dB(i)	>26 dB	Horiz. 45-27°	Type 1 Tip 1	106 cm	10	117 x 37 x 29	0.126
DTX-92 F	B.IV-V 21-69 (470-862 MHz)	92	12 - 18.5 dB(i)	>30 dB	Horiz. 50-26°	Type 1 Tip 1	237 cm	1	124 x 33 x 9	0.037
DTX-92 FC						Type 2 Tip 2		1	121 x 41 x 9	0.046

It is possible to upgrade antenna with:

- active balun or complete dipol with built-in amplifier DIGI-YAGI (see page 25)
- passive balun with different types of LTE filters (see page 27)

Možna naknadna nadgradnja antene:

- z aktivnim simetričnim členom ali celotnim dipolom z vgrajenim ojačevalnikom DIGI-YAGI (glej stran 25)
- s pasivnim simetričnim členom, z različnimi vrstami LTE filtrov (glej stran 27)

Gain diagram / Graf dobitkov

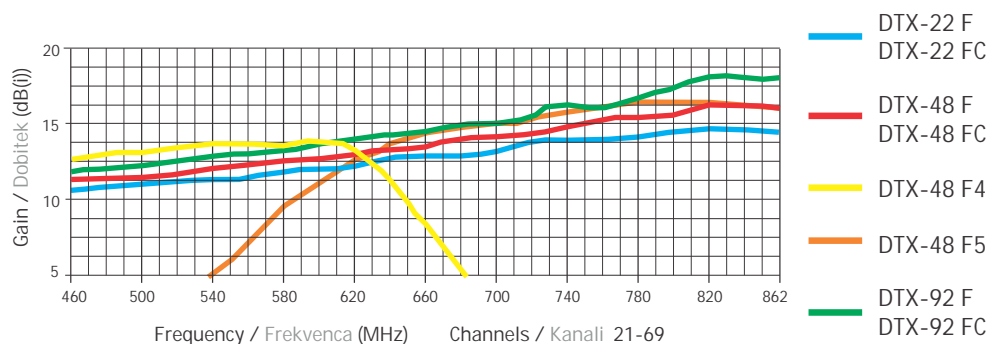

Reflector / Reflektor

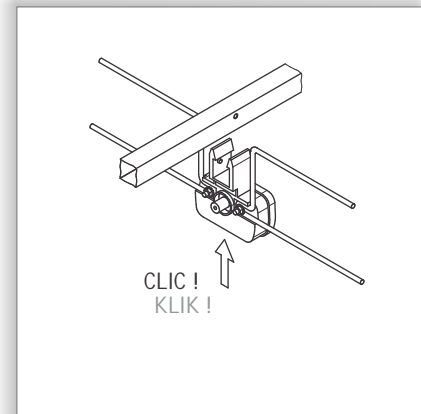
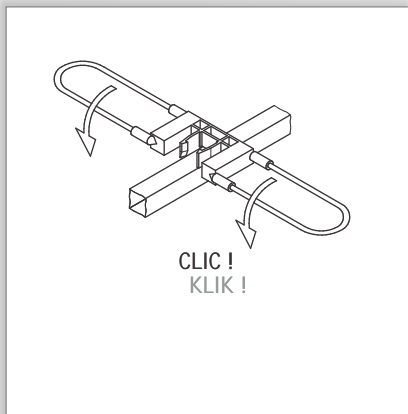
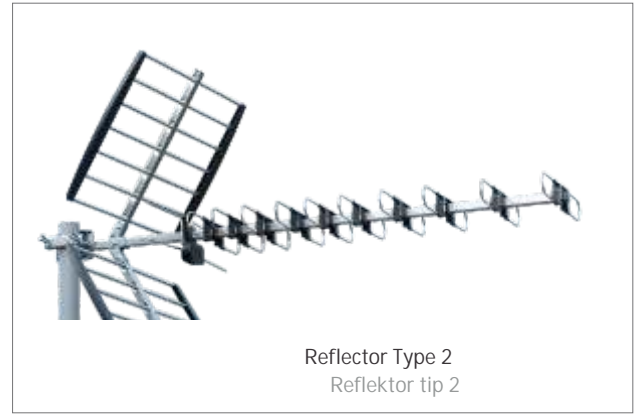
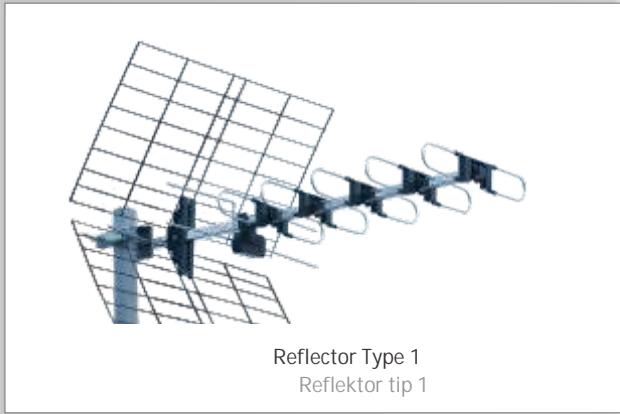

YAGI Antennas - series DTM

YAGI antene - serija DTM

UHF
Ch. 21-69 (470-862 MHz)



DTM-27 F

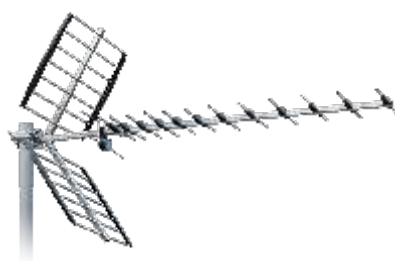

DTM-44 F



DTM-91 F

Impedance	75 Ohm	Dipole	DTX	Polarization	Horiz./Vert.	Antenna carrier	18 x 18	Mounting on mast	D = 20 - 62 mm
Impedanca		Dipol	"F"	Polarizacija		Nosilec antene		Montaža na drog	

D outside mast diameter / zunanji premer droga

Technical data / Tehnični podatki

Type Tip	Channels (frequency) Kanali (frekvenca)	No. of elements Število elementov	Gain Dobitek	F/B ratio Razmerje naprej-nazaj	Beam width Širina glav. lista	Reflector Reflektor	Lenght Dolžina antene	Packing Pakiranje		
								pcs. kom	cm	m ³
DTM-27 F	B.IV-V 21-69 (470-862 MHz)	27	10 - 14 dB(i)	>26 dB	Horiz. 42° Vert. 54°	Type 1 Tip 1	103.5 cm	1 10	105 x 40.5 x 11.5 108 x 42 x 51	0.049 0.231
DTM-44 F		44	11 - 15 dB(i)	>27 dB	Horiz. 34° Vert. 48°	Type 2 Tip 2	126.5 cm	1 10	128 x 40.5 x 11.5 131 x 41 x 51	0.060 0.274
DTM-91 F		91	12 - 18 dB(i)	>30 dB	Horiz. 28° Vert. 38°		189.5 cm	1	114 x 40.5 x 9.5	0.044

It is possible to upgrade antenna with:

- active balun or complete dipol with built-in amplifier DIGI-YAGI (see page 25)
- passive balun with different types of LTE filters (see page 27)

Možna naknadna nadgradnja antene:

- z aktivnim simetričnim členom ali celotnim dipolom z vgrajenim ojačevalnikom DIGI-YAGI (glej stran 25)
- s pasivnim simetričnim členom, z različnimi vrstami LTE filtrov (glej stran 27)

Gain diagram / Graf dobitkov

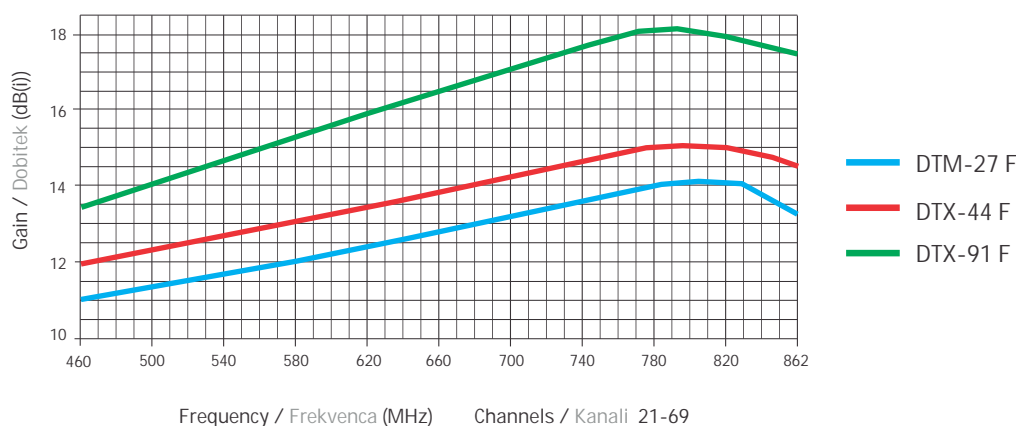

Reflector / Reflektor

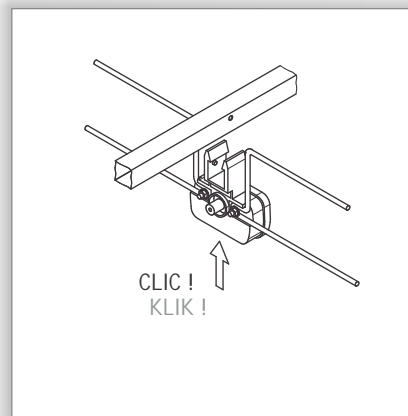
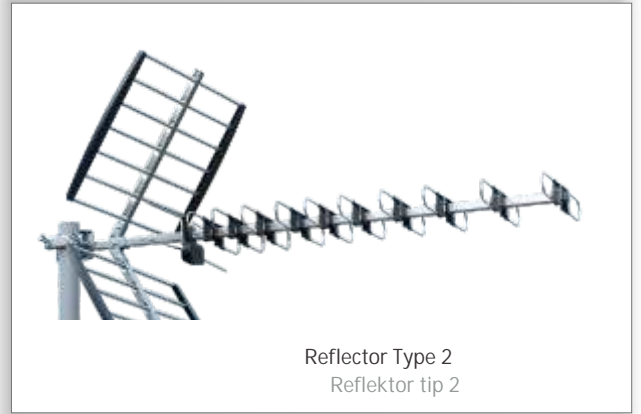
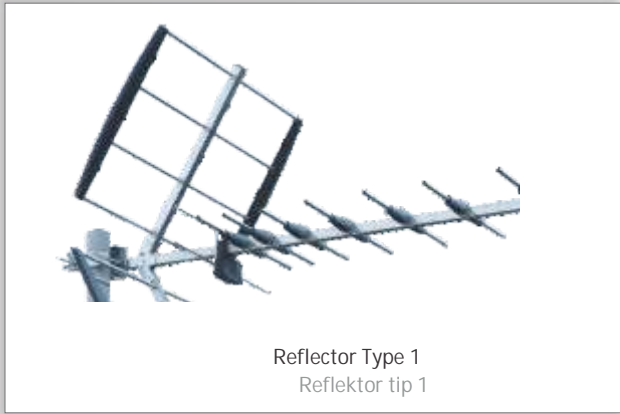

DTM Directors / DTM direktorji



YAGI Antennas

YAGI antene

UHF
Ch. 21-69 (470-862 MHz)

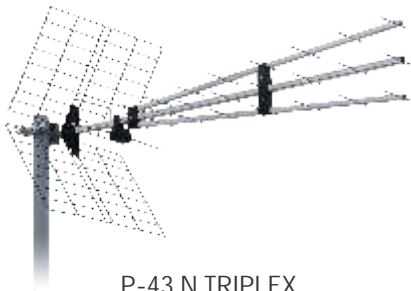

P-43 N TRIPLEX

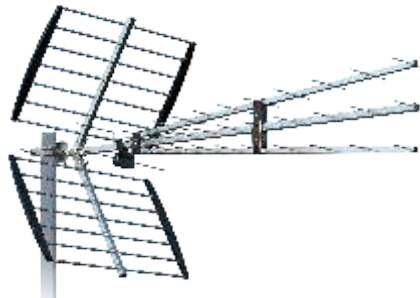

P-47 N TRIPLEX

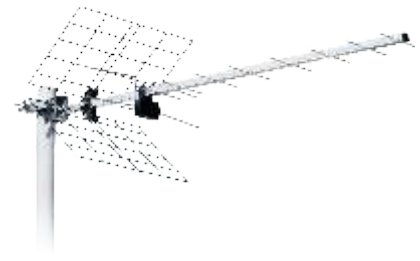

UF-13 F45N

Impedance	75 Ohm	Polarization	Horiz./Vert.	Mounting on mast	D = 20-62 mm
Impedanca		Polarizacija		Montaža na drog	

D outside mast diameter / zunanji premer droga

Technical data / Tehnični podatki

Type Tip	Channels (frequency) Kanali (frekvenca)	No. of elements Število elementov	Gain Dobitek	F/B ratio Razmerje naprej-nazaj	Beam width Širina glav. lista	Antenna carrier Nosilec antene	Reflector Reflektor	Length Dolžina antene	Packing Pakiranje		
									pcs. kom.	cm	m ³
P-43 N TRIPLEX*	Ch. 21-69 (470-862 MHz)	43	9.5 - 15 dB(i)	28 dB	Horiz. 32° Vert. 35°	1 x 18 x 18 2 x 14 x 14	Type 2 Tip 2	119 cm	1** 10	121 x 32 x 15 121 x 33 x 29	0.058 0.116
P-47 N TRIPLEX*		47	11 - 17 dB(i)	>28 dB	Horiz. 45° Vert. 24°		Type 3 Tip 3	128.5 cm	1 1 5	127.5 x 40.5 x 9.5 131 x 40.5 x 15 129 x 41 x 28	0.049 0.080 0.148
UF-13 F45N*		Ch. 21-38 (470-606 MHz)	13	7.5 - 11 dB(i)	20 dB	Horiz. 50° Vert. 56°	18 x 18	Type 1 Tip 1	101 cm	1** 10	102 x 23 x 8 111 x 34 x 27
UF-13 F4	12 dB(i)			>21 dB	Horiz. ±30°	18 x 12			143.5 cm	10	148 x 33.5 x 33
UF-13 F5	12 dB(i)			>20 dB	Horiz. ±17°		111.5 cm	10	144 x 33.5 x 30	0.145	

- * It is possible to upgrade antenna with:
- active balun or complete dipol with built-in amplifier DIGI-YAGI (see page 25)
 - passive balun with different types of LTE filters (see page 27)
- * Možna naknadna nadgradnja antene:
- z aktivnim simetričnim členom ali celotnim dipolom z vgrajenim ojačevalnikom DIGI-YAGI (glej stran 25)
 - s pasivnim simetričnim členom, z različnimi vrstami LTE filtrov (glej stran 27)
- ** Single white carton box with print / Posamična bela embalaža, potiskana.

Gain diagram / Graf dobitkov

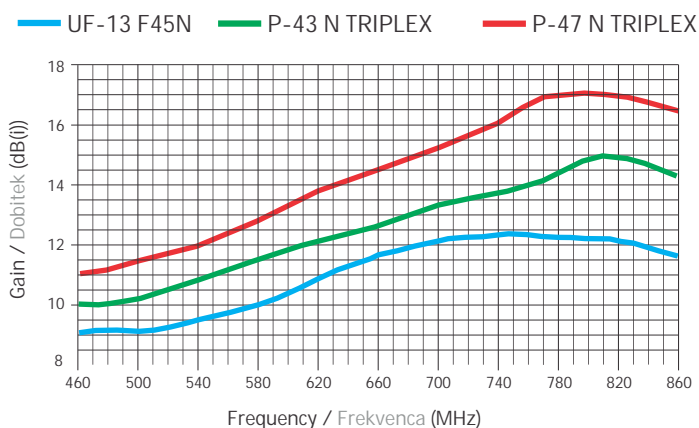

Reflector / Reflektor

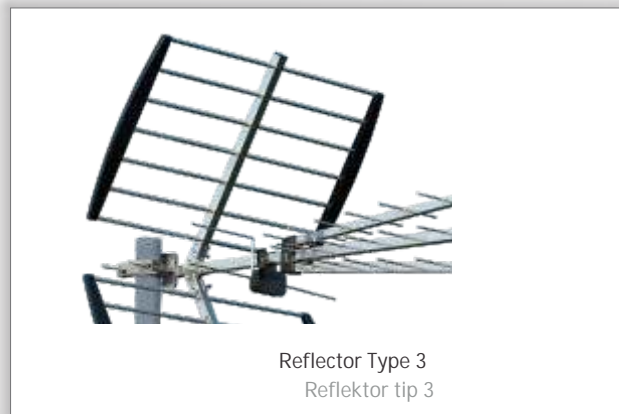
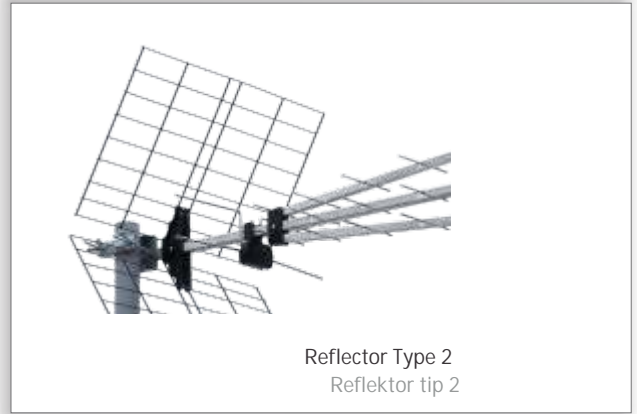
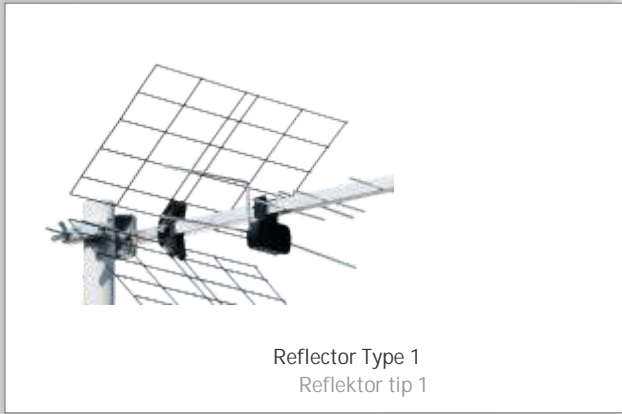

Triplex detail / Triplex detalj

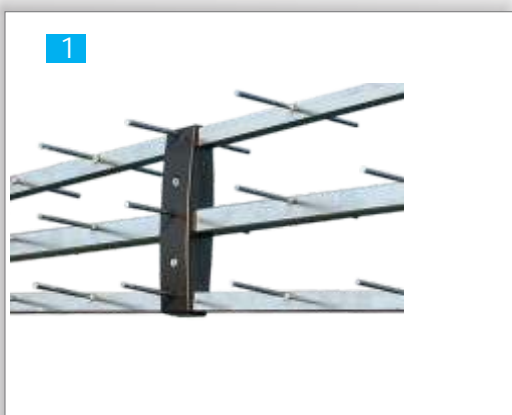

Antenna Amplifiers for YAGI Antennas

Antenski ojaèevalniki za YAGI antene



Low noise antenna amplifier DIGI YAGI is made as single active balun .It is used only for YAGI antenna with DTX "F" dipole (all antennas in series DTX, DTM ,TRIPLEX and some UF antennas) It can be used for upgrading existing antenna .Amplifier can be supplied from outside power supply *or directly from DVB T receiver. Antenna is receiving signals only if balun is power supplied. Power supply is provided through the same coax. cable as reception signal .

Nizkošumni antenski ojaèevalnik DIGI YAGI je narejen kot samostojni aktivni simetrični èlen .Uporablja se le pri YAGI anteni ,ki ima DTX "F" dipol (vse antene serije DTX ,DTM ,TRIPLEX in nekatere UF antene) Uporablja se za naknadno vgradnjo v obstojeèe anteno .Napaja se z zunanjim napajalnikom * ali direktno z digitalnim sprejemnikom. Antena sprejema signale samo če je simetrični èlen napajan z električno energijo. Napajanje poteka preko istega koaks. kabla kot je prenos sprejetega signala.

Technical data / Tehnièni podatki

Amplifier type Tip ojaèevalnika	Frequency range Frekveneni pas	Amplification Ojaèanje	Noise figure Sumno št.	P-P Valovanje	Maks. output level Maks. jakost izhod. signala	Power supply Napajanje	Impedance / Connector Impedanca / konektor
DIGI-YAGI 16U ¹⁾	Ch. 21 - 69 470 - 862 MHz	16 dB @ 5-24 VDC	2 dB	1.8 dB	98 dBmV	22 mA @ 5-24 VDC	75 Ohm "F" female "F" ženski
DIGI-YAGI 18-U		18 dB @ 5-24 VDC		1.4 dB	96 dBmV	25 mA @ 5-24 VDC	
DIGI-YAGI 18-U + LTE filter LTE 800 LIGHT ²⁾	Ch. 21 - 60 470 - 790 MHz						

* Recommended power supply with output DC12V, 150 mA / Priporoèamo napajalnik z izhodom izm. 12V, 150 mA.

1) Antenna amplifier DIGI-YAGI 16U has built-in 3 NOTCH (stop band) filters for TETRA 400 and GSM 900 Mhz and 1.1 GHz frequencies / Antenski ojaèevalnik DIGI-YAGI 16U ima vgrajene 3 sesalne filtre proti motnjam TETRA 400 in GSM 900 MHz in 1.1 GHz frekvenc

2) This antenna amplifier has built-in LTE CUT filter LTE 800 LIGHT for cutting LTE 800 frequencies 791-862 MHz (see page 27).
Ta antenski ojaèevalnik ima vgrajen LTE sesalni filter LTE 800 LIGHT za dušenje LTE 800 signalov 791-862 MHz (glej stran 27).

GAIN = gain of passive antenna + amplification of DIGI-YAGI
Dobitek = dobitek pasivne antene + ojaèanje DIGI-YAGI

Example / Primer:

antenna/ antena DTX-48F: + DIGI YAGI 16U = active antenna/ aktivna antena
16 dB(i) + 16 dB = 32 dB(i)

Diagram of amplification / Graf ojaèenja

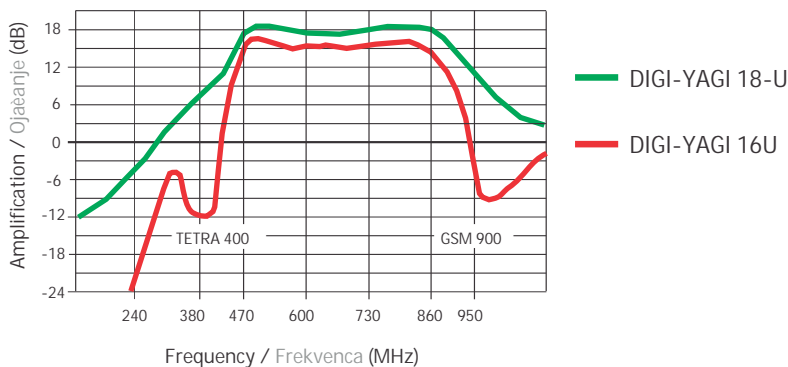

Examples of use / Primeri uporabe

1st option / Prva opcija

Independent amplifier DIGI YAGI

DTX "F" dipole's housing has to be opened and afterwards the existing passive balun has to be replaced by DIGI YAGI amplifier. Tools are required for this intervention.

Samostojni ojaèevalnik DIGI YAGI

Plastièno ohišje DTX "F" dipola je potrebno odpreti in zamenjati obstojeèi pasivni simetrični èlen z ojaèevalnikom DIGI YAGI. Za ta poseg je potrebno orodje.



2nd option / Druga opcija

Complete active DTX "F" dipole

Amplifier DIGI YAGI is already installed inside DTX "F" dipole. It is necessary to replace the existing passive DTX "F" dipole with an active DTX "F" dipole. Tools aren't required.

Kompleten aktivni DTX "F" dipol

Ojaèevalnik DIGI YAGI je že vgrajen v DTX "F" dipolu. Potrebno je le zamenjati obstojeèi pasivni DTX "F" dipol z aktivnim DTX dipolom. Orodje ni potrebno.

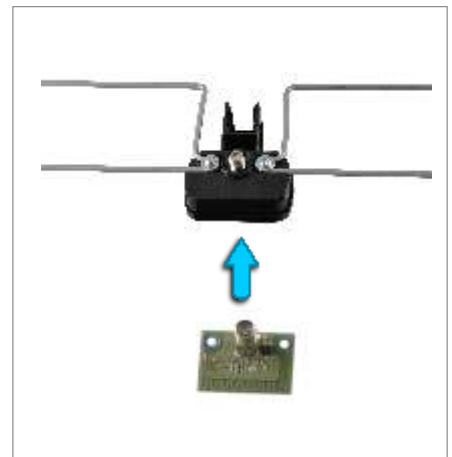

Examples of connection / Primeri prikljuèitve

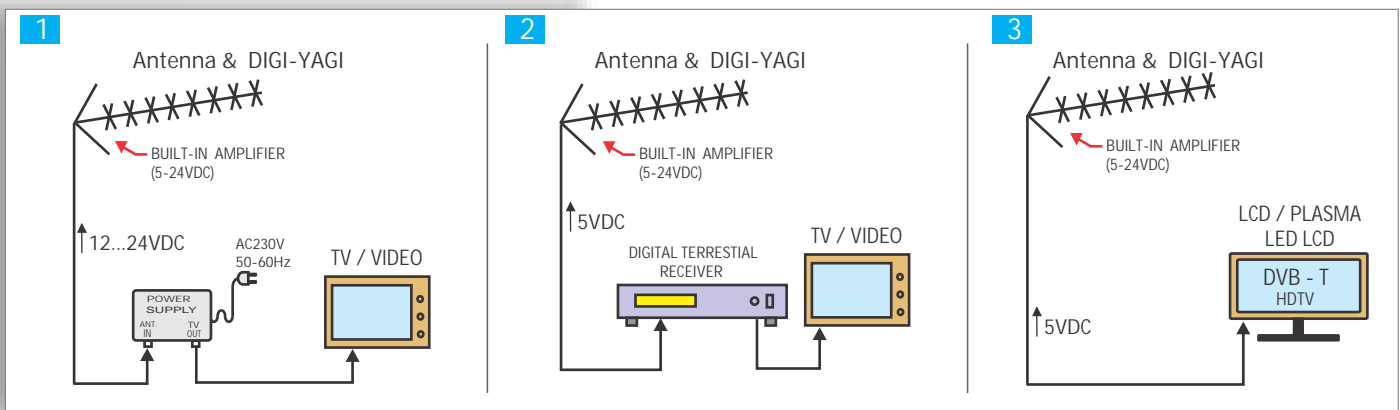

LTE Filters for LOG and YAGI Antennas

LTE filtri za LOG in YAGI antene



LTE filters are built-in in balun (in YAGI antennas) or in antenna's aluminium carrier (in log-periodic antennas). We have several different LTE CUT filters:

- LTE 800 LIGHT

Filter passes all frequencies from 0 to 790 MHz and primary cuts signals above 790 MHz. Average attenuation of LTE 4G frequencies from 791 to 862 MHz is -20 dB.

- LTE 800 HQ BASIC (designed with HQ SAW filters)

Filter passes UHF DVB-T band from 470 to 790 MHz and primary cuts signals above 791 MHz. Average attenuation of LTE 4G frequencies from 791 to 862 MHz is -30 dB.

- LTE 800 HQ PLUS (designed with HQ SAW filters)

LTE 800 HQ PLUS filter is an upgrade of LTE 800 HQ BASIC filter. It has additional notch / cut filters for TETRA 400 and GSM 900 frequencies. Average attenuation of LTE 4G frequencies from 791 to 862 MHz is -35 dB.

- LTE 700/800 LIGHT

Filter passes all frequencies from 0 to 697 MHz and primary cuts signals above 697 MHz. Average attenuation of LTE 4G frequencies from 698 to 862 MHz is - dB.

- LTE 700/800 HQ BASIC (designed with HQ SAW filters)

Filter passes UHF DVB-T band from 470 to 697 MHz and primary cuts signals above 697 MHz. Average attenuation of LTE 4G frequencies from 698 to 862 MHz is - dB.

LTE filtri so vgrajeni v simetr. èlen (pri YAGI antenah) ali v nosilec antene (pri LOG antenah). Imamo veè tipov LTE sesalnih filtrov:

- LTE 800 LIGHT

Spustijo vse frekvence 0 - 790 MHz in primarno zadušijo signale nad 790 MHz. Zadušijo LTE 4G frekvence 791 - 862 MHz do -20 dB.

- LTE 800 HQ BASIC (narejen z HQ SAW filtri)

Izdatno zadušijo LTE 4G frekvence 791 - 862 MHz do -30 dB

- LTE 800 HQ PLUS (narejen z HQ SAW filtri)

LTE 800 HQ PLUS filter je nadgradnja filtra LTE 800 HQ BASIC. Ima vgrajene dodatne notch / cut filtre za filtriranje TETRA 400 in GSM 900 frekvenc. Zadušijo LTE 4G frekvence 791 - 862 MHz do -5 dB.

- LTE 700/800 LIGHT

Spustijo vse frekvence 0 - 697 MHz in primarno zadušijo signale nad 697 MHz. Zadušijo LTE 4G frekvence 689 - 862 MHz do - dB.

- LTE 700/800 HQ BASIC (narejen z HQ SAW filtri)

Izdatno zadušijo LTE 4G frekvence 698 - 862 MHz do - dB

Technical data / Tehnični podatki					
Type Tip	LTE 800 LIGHT	LTE 800 HQ BASIC	LTE 800 HQ PLUS	LTE 700/800 LIGHT	LTE 700/800 HQ BASIC
Function Funkcija	Attenuating LTE 800 signals / Dušenje LTE 800 signalov			Attenuating LTE 700 + LTE 800 signals / Dušenje LTE 700 + LTE 800 signalov	
Cutting frequencies Dušenje frekvenc	791 - 862 MHz: -20 dB	791 - 862 MHz: -30 dB	791 - 862 MHz: -35 dB	698 - 862 MHz: dB	698 - 862 MHz: dB
Loss on Channels Slabljenje na kanalih	-3.5 dB @ Ch.59 -6.2 dB @ Ch.60	-2.1 dB @ Ch.59 -3.5 dB @ Ch.60		dB @ Ch.48 dB @ Ch.49	dB @ Ch.48 dB @ Ch.49
Pass freq. range - internal loss Izguba na prep. pasu	0 - 790 MHz: <0.7 dB	470 - 790 MHz: <1.2 dB		0 - 697 MHz: dB	470 - 697 MHz: dB
Impedance Impedanca	75 Ohm				
Connector Konektor	"F" - female / "F" - ženski				
Electro-static protection Elektrostatična zaščita	Yes / Da				
Additional mark in antenna - Eg. Dodatna oznaka pri anteni - Npr.	DTX-22 FLT	DTX-22 FL	DTX-22 FL+	DTX-22 FLT7	DTX-22 FL7

Diagram of attenuation / Graf dušenja

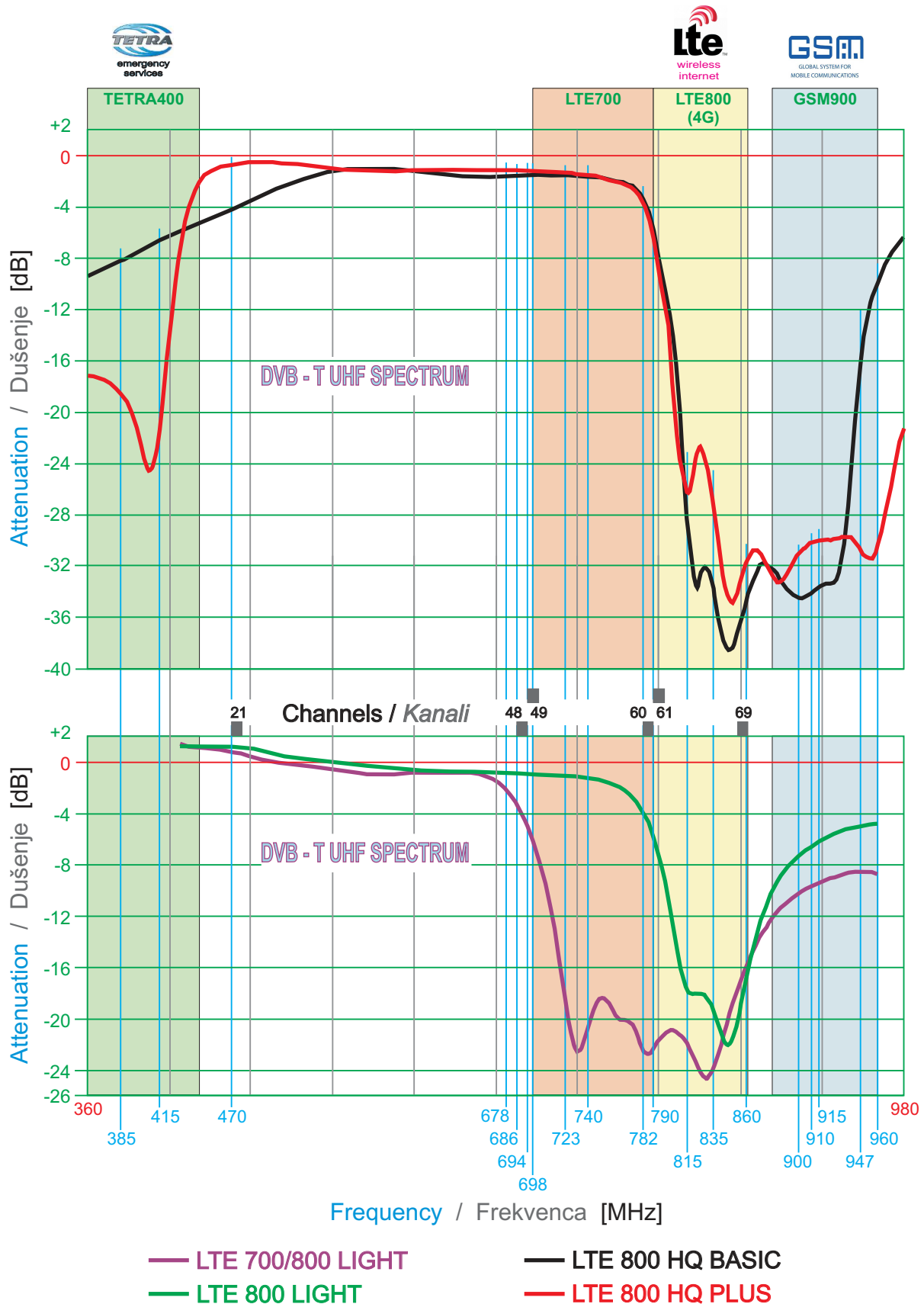

Indoor Antennas

Sobne antene

UHF
Ch. 21-69 (470-862 MHz)



G-2235-06



G-2235-07



G-2235-10

Impedance	75 Ohm	Power supply	AC 230 V / 50 Hz	Connector for connection on TV set	IEC 169-2 male / moski
Impedanca		Napajanje	DC 12 V / 100 mA	Konektor za priklop na TV	

Technical data / Tehni?ni podatki

Type Tip	Channels (frequency) Kanali (frekvenca)	Common gain Skupni dobitek	Gain control Kontrola dobitka	Packing Pakiranje		
				pcs. kom	cm	m ³
G-2235-06	Ch. 2-12 (47 - 230 MHz) Ch. 21-69 (470 - 862 MHz)	20 dB(i) max. 36 dB(i)	15 dB 25 dB	10	70 x 47 x 29	0.095
G-2235-07	Ch. 2-12 (47 - 230 MHz) Ch. 21-69 (470 - 862 MHz)	26 dB(i) max. 36 dB(i)	15 dB 25 dB	10	72 x 65 x 30	0.140
G-2235-08	Ch. 2-69 (40 - 862 MHz)	VHF 26 dB(i) UHF 28 dB(i)	20 dB	10	55 x 44 x 29	0.070
G-2235-10	Ch. 2-69 (40 - 862 MHz)	VHF 20 dB(i) UHF 25 dB(i)	20 dB	10	34 x 35 x 48	0.057

- 1 Antenna carriers / Nosilca antene
Aluminium tube / aluminijasta cev
- 2 Iron parts / Kovinski deli
hot galvanized steel / vroče cinkano jeklo
- 3 Fixing to mast / Pritrditev antene na drog
"U" screw M6, without inclination
"U" vijak M6, brez inklinacije
outside mast diameter / zunanji premer droga
D = 20 ... 50 mm
- 4 Directors / Direktorji
aluminium rods / palice iz aluminija
dia. f 4 mm
- 5 Plastics / Plastika
ABS UV resistant / ABS UV obstojna
- 6 Coaxial cable with FME connector at the end of the cable /
Koaksialni kabel z FME konektorjem na koncu kabla

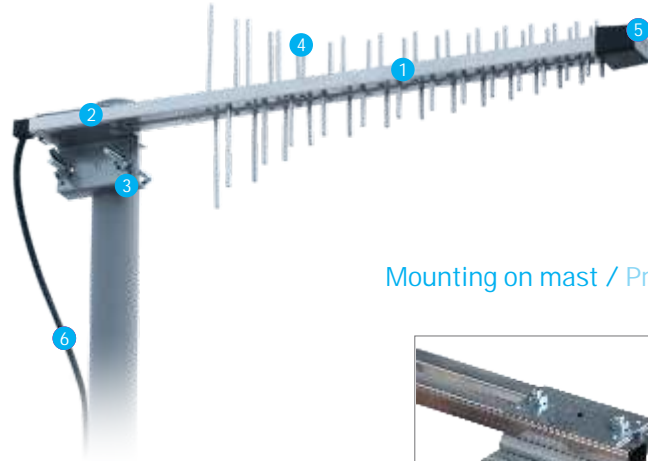

Mounting on mast / Pritrditev na drog



Standard version: only for vertical polarisation
Standardna izvedba: samo za vertikalno polarizacijo

Standard connector is FME female connector. Other connector (SMA, N) is also possible by demand.

Standardni konektor je FME ženski konektor. Možni so tudi drugi konektorji (SMA, N) po dogovoru.



FME connector
FME konektor

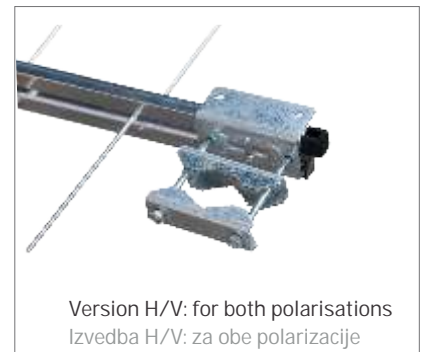

Version H/V: for both polarisations
Izvedba H/V: za obe polarizacije

Professional antenna is used primarily for the reception of 2G/3G/4G mobile operator's signals in areas where mobile communication is impossible due to low signal level. The antenna is connected via FME female connector directly on the mobile phone or on the card for wireless internet (e.g. 3G/4G USB modem). Additional adapter for connecting antenna to your 3G/4G modem is required.

Some professional antennas are used for wireless LAN signal transmission.

Professional antenna has reliable and robust design for optimal performance and long life time expectancy. Antenna does not require additional assembling, because it's already assembled.

Impedance of all professional antennas is 50 Ohm.

Profesionalna antena se uporablja predvsem za sprejem 2G/3G/4G signala mobilnih operaterjev na področjih, kjer je uporaba mobilnega aparata nemogoča zaradi prenizkega nivoja signala. Antena se priklapi preko vgrajenega FME ženskega konektorja direktno na mobilni aparat ali na kartico za brezžični internet (npr. 3G/4G USB modem). Za priklap antene na 3G/4G modem boste potrebovali še dodatni adapter.

Nekatere profesionalne antene se uporabljajo tudi za prenos brezžičnega LAN signala.

Profesionalna antena ima zanesljiv in robusten dizajn za optimalno delovanje in dolgo življensko dobo. Antene ni potrebno sestavljati pred montažo na drog, saj so vsi sprejemni deli že mehansko sestavljeni.

Impedanca vseh profesionalnih anten je 50 Ohm.



P-30 UMTS



P-54 GSM-UMTS

Technical data / Tehnični podatki

Type Tip	Channels (frequency) Kanali (frekvenca)	No. of elements Število elementov	Gain Dobitek	F/B ratio Razmerje naprej-nazaj	Beam width Širina glav. lista	Max. VSWR Maks. VSWR	Length Dolžina antene	Packing Pakiranje		
								pcs. kom.	cm	m ³
P-30 UMTS*	UMTS (1800 - 2170 MHz)	30	10.5 - 11.5 dB(i)	24 dB	Horiz. 47° Vert. 52°	<2.0 : 1	47 cm	15	77 x 30 x 23	0.053
P-54 GSM-UMTS*	GSM (890-960 MHz) DCS (1710 - 1880 MHz) UMTS (1920 - 2170 MHz)	54	10 - 12 dB(i)	24 dB	Horiz. 43° Vert. 34°	<1.6 : 1	56.5 cm	15	111 x 34 x 27	0.102

* Standard antenna has 10 m coax. cable and FME female connector / Standardna antena ima 10 m koaks. kabla in FME ženski konektor

Gain diagrams / Grafi dobitek

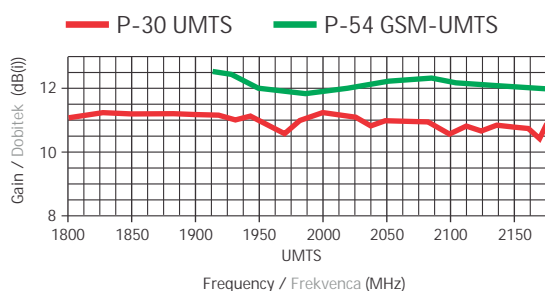
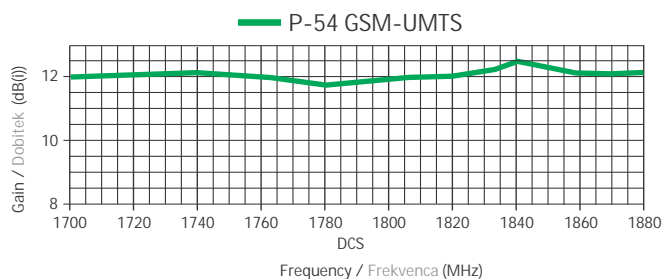
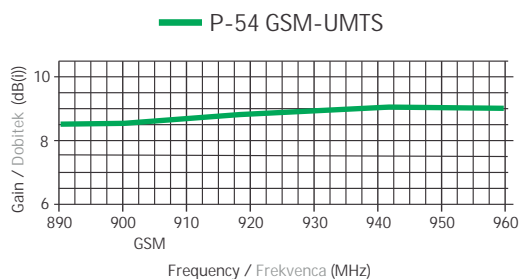

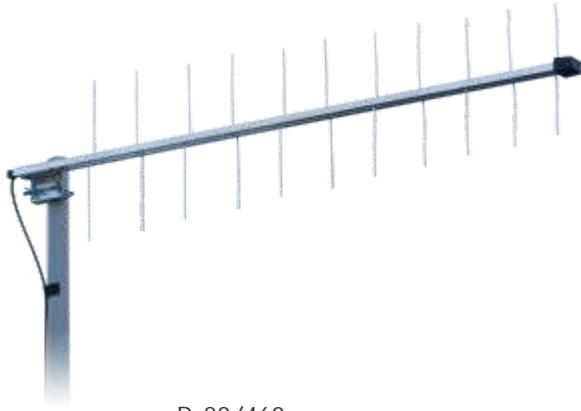

P-22/460



P-28 NMT/GSM

Technical data / Tehnični podatki

Type Tip	Channels (frequency) Kanali (frekvenca)	No. of elements Število elementov	Gain Dobitek	F/B ratio Razmerje naprej-nazaj	Beam width Sirina glav. lista	Max. VSWR Maks. VSWR	Lenght Dolžina antene	Packing Pakiranje		
								pcs. kom.	cm	m ³
P-16 GSM*	GSM (850 - 960 MHz)	16	9 dB(i)	20 dB	Horiz. 68° Vert. 64°	1.6 : 1	49.5 cm	15	111 x 34 x 27	0.102
P-18 NMT*	NMT (380 - 500 MHz)	18	10 dB(i)	21 dB	Horiz. 78° Vert. 60°	<1.5 : 1	97.5 cm	10	100 x 78.5 x 17	0.133
P-18/460*	NMT (450 - 470 MHz)	18	11 dB(i)	23 dB	Horiz. 76° Vert. 53°	<1.5 : 1	100 cm	10	117 x 37 x 29	0.126
P-22/460*	NMT (450 - 470 MHz)	22	12 dB(i)	25 dB	Horiz. 49° Vert. 73°	<1.5 : 1	123.5 cm	10	144 x 33.5 x 30	0.145
P-28 NMT/GSM*	NMT/GSM (380 - 960 MHz)	28	8 - 10 dB(i)	22 dB	Horiz. 80° Vert. 62°	<1.5 : 1	82 cm	10	94 x 47 x 34	0.150
P-36 GSM*	GSM (850 - 960 MHz)	36	11 dB(i)	26 dB	Horiz. 48° Vert. 57°	<1.5 : 1	100 cm	10	111 x 34 x 27	0.102
P-52 GSM/DCS*	GSM (850 - 960 MHz) DCS (1710 - 1880 MHz)	52	GSM: 9 dB(i) DSC: 10.5 dB(i)	25 dB	Horiz. 45° Vert. 36°	GSM: <1.5 : 1 DSC: <2 : 1	93 cm	10	111 x 34 x 27	0.102
P-54 GSM/UMTS*	GSM (850 - 960 MHz) DCS (1710 - 1880 MHz) UMTS (1920 - 2170 MHz)	54	10 - 12 dB(i)	24 dB	Horiz. 43° Vert. 34°	<1.6 : 1	56.5 cm	15	111 x 34 x 27	0.102

* Standard antenna has 10 m coax. cable and FME female connector / Standardna antena ima 10 m koaks. kabla in FME ženski konektor

Professional Antennas - NMT, GSM

Profesionalne antene - NMT, GSM

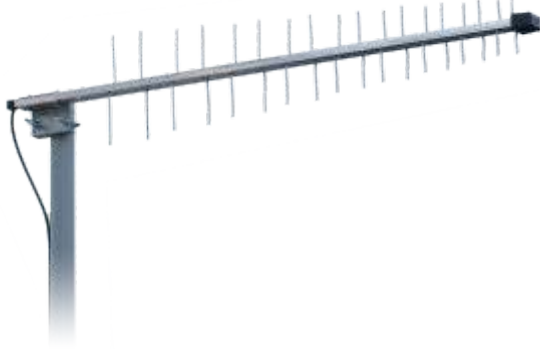

P-36 GSM



P-52 GSM/DSC

Gain diagrams / Grafi dobitkov

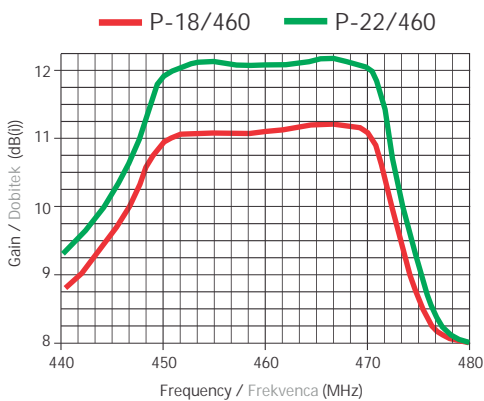
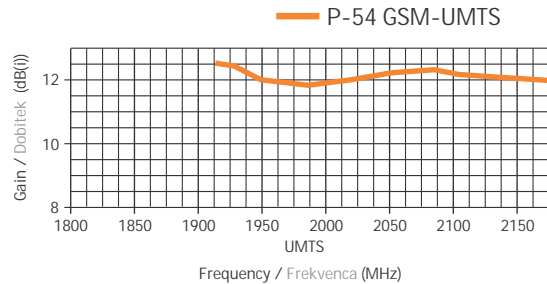
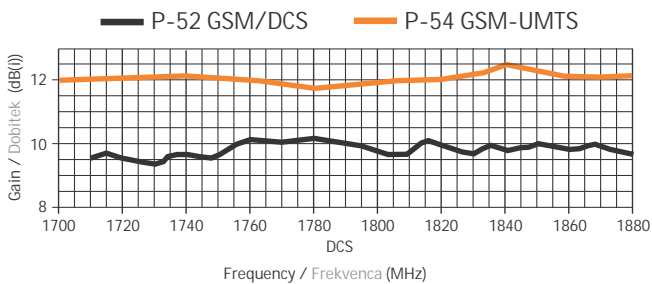
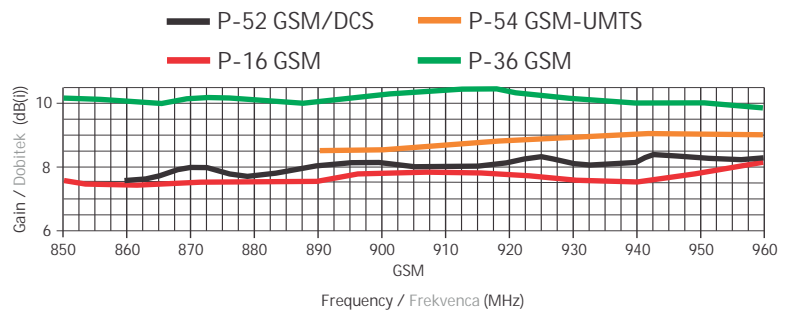
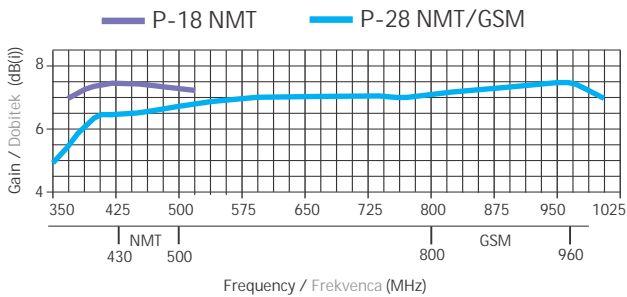

P-44 LAN



Technical data / Tehnični podatki										
Type Tip	Channels (frequency) Kanali (frekvenca)	No. of elements Število elementov	Gain Dobitek	F/B ratio Razmerje naprej-nazaj	Beam width Sirina glav. lista	Max. VSWR Maks. VSWR	Lenght Dolžina antene	Packing Pakiranje		
								pcs. kom	cm	m ³
P-44 LAN	2.4 - 2.5 GHz	44	12 dB(i)	24 dB	Horiz. 34° Vert. 42°	<2.0 : 1	60.5 cm	25	111 x 34 x 27	0.102

The Professional antenna P-44 LAN is used for wireless LAN signal transmission. Coaxial cable and connection: cable length 3 m, without "FME" connector on cable end.

Profesionalna antena P-44 LAN se uporablja za prenos brezžičnega LAN signala (WLAN). Koaksialni kabel in priklp: dolžina 3 m, brez konektorja "FME" na koncu kabla.

Gain diagram / Graf dobitkov

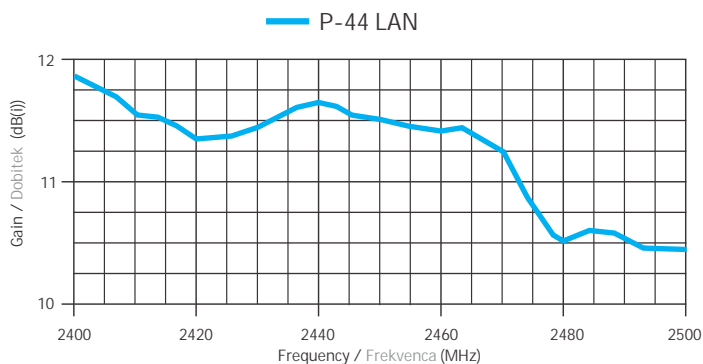

Professional Antennas - Wi-Fi, LTE

Profesionalne antene - Wi-Fi, LTE

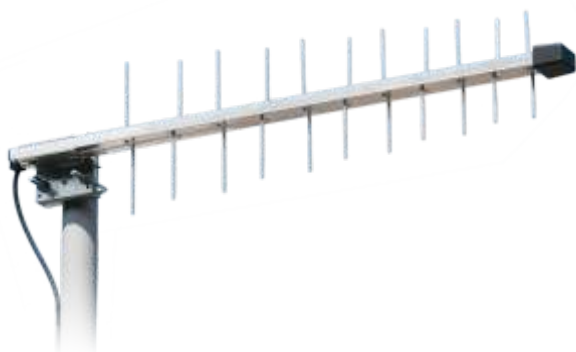

P-22 LTE

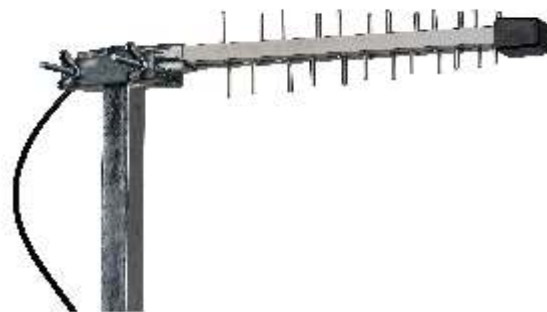

P-24 WL

Technical data / Tehni?ni podatki

Type Tip	Channels (frequency) Kanali (frekvenca)	No. of elements Stevilo elementov	Gain Dobitek	F/B ratio Razmerje naprej-nazaj	Beam width Sirina glav. lista	Max. VSWR Maks. VSWR	Lenght Dolžina antene	Packing Pakiranje		
								pcs. kom.	cm	m ³
P-10 LTE*	LTE 800 (790 - 862 MHz)	10	8 dB(i)	22 dB	Horiz. 82° Vert. 60°	1.8 : 1	38.5 cm	1	39 x 25 x 7	0.007
P-22 LTE*		22	11 dB(i)	24 dB	Horiz. 66° Vert. 52°	1.7 : 1	78.5 cm	10	80 x 25 x 7 92 x 33 x 29	0.014 0.090
P-24 WL**	Wi-Fi & LTE 2.6 2.4 - 2.7 GHz	24	11 dB(i)	24 dB	Horiz. 48° Vert. 34°	1.6 : 1	41 cm	25	92 x 33 x 29	0.088
P-46 WL**		46	13 dB(i)	25 dB	Horiz. 26° Vert. 22°	1.5 : 1	63.5 cm	20	111 x 34 x 27	0.102

* Standard antenna has 10 m coax. cable and FME female connector / Standardna antena ima 10 m koaks. kabla in FME ženski konektor

** Antenna has 3 m coax. cable and FME female connector / Antena ima 3 m koaks. kabla in FME ženski konektor

Gain diagrams / Grafi dobitkov

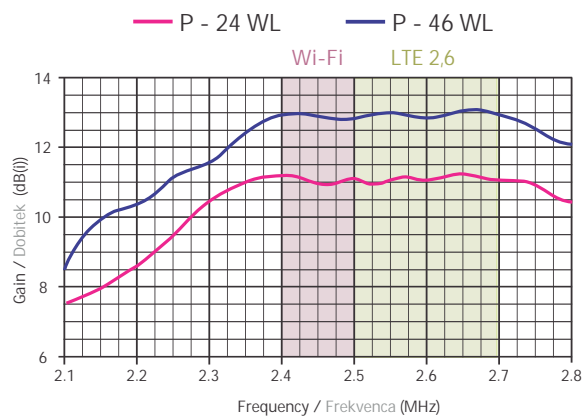
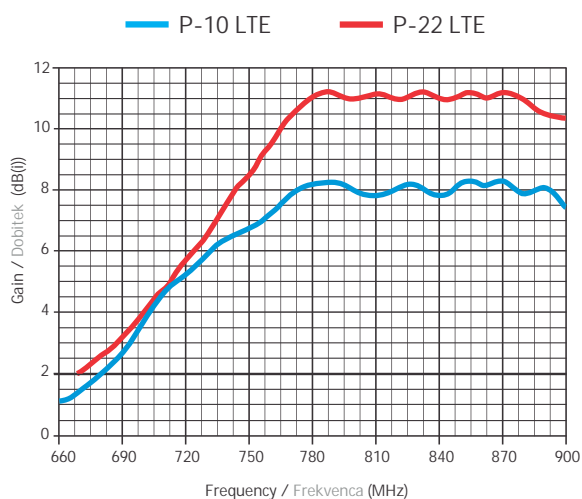



P-42 UNICOM

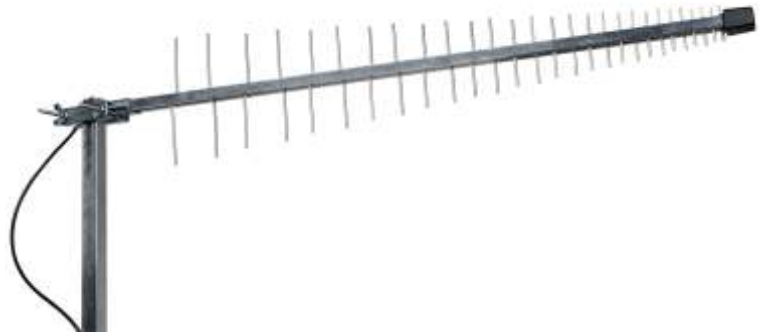

P-56 UNICOM

Technical data / Tehni?ni podatki

Type Tip	Channels (frequency) Kanali (frekvenca)	No. of elements Število elementov	Gain Dobitek	F/B ratio Razmerje naprej-nazaj	Beam width Širina glav. lista	Max. VSWR Maks. VSWR	Length Dolžina antene	Packing Pakiranje		
								pcs. kom.	cm	m ³
P-30 UNICOM*	LTE 800 (790 - 862 MHz) GSM 900 (880 - 960 MHz) DSC 1800 (1710 - 1880 MHz) UMTS (3G) (1920 - 2170 MHz) Wi-Fi (WLAN) (2401 - 2495 MHz) LTE 2.6 GHz (2.5 - 2.7 GHz)	30	6.5 - 8 dB(i)	23 dB	Horiz. 76° Vert. 68°	<1.5 : 1	45 cm	20	92 x 33 x 29	0.088
P-42 UNICOM*		42	8 - 9.5 dB(i)	23 dB	Horiz. 64° Vert. 56°		72 cm	10	111 x 34 x 16	0.060
P-56 UNICOM*		56	9.5 - 11.5 dB(i)	24 dB	Horiz. 52° Vert. 44°		98 cm	10	111 x 34 x 27	0.102
P-58 L700 UNI**		58	9 - 11 dB(i)	23 dB	Horiz. 54° Vert. 46°		<1.6 : 1	107 cm	10	111 x 34 x 27

* Standard antenna has 10 m coax. cable and FME female connector / Standardna antena ima 10 m koaks. kabla in FME ženski konektor

** Antenna P-58 L700 UNI also covers band LTE 700 (698-790 MHz). Standard antenna has 10 m coax. cable and FME female connector / Antena pokriva tudi pas LTE 700 (698 - 790 MHz). Standardna antena ima 10 m koaks. kabla in FME ženski konektor

Gain diagram / Graf dobitkov

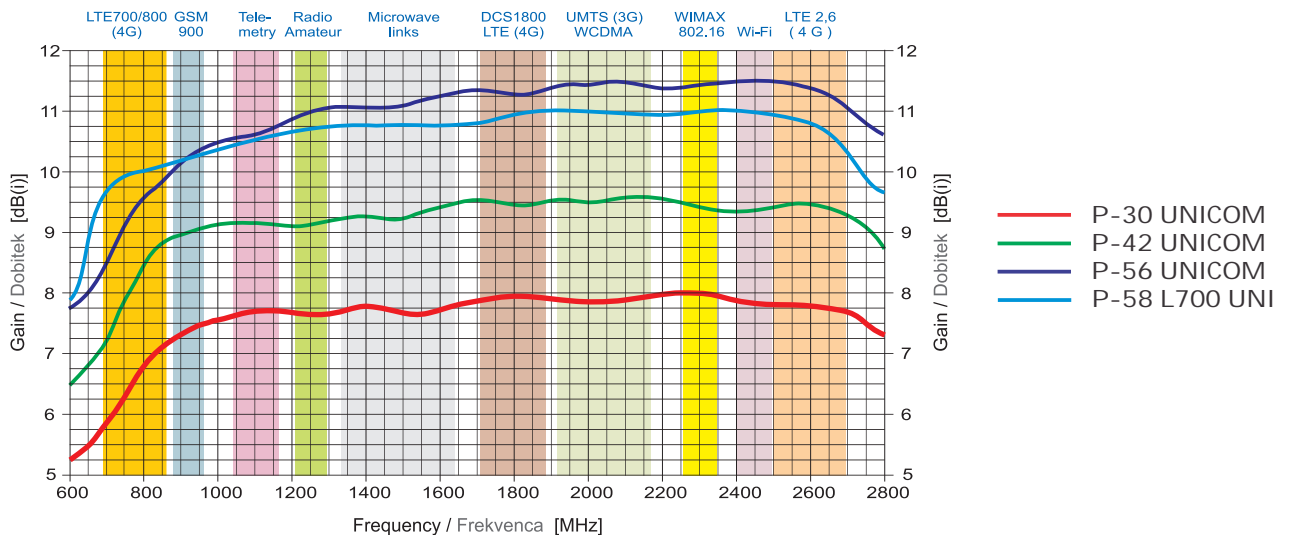

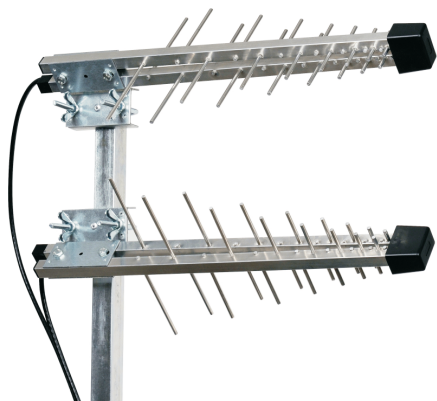

P-30 UNICOM MIMO

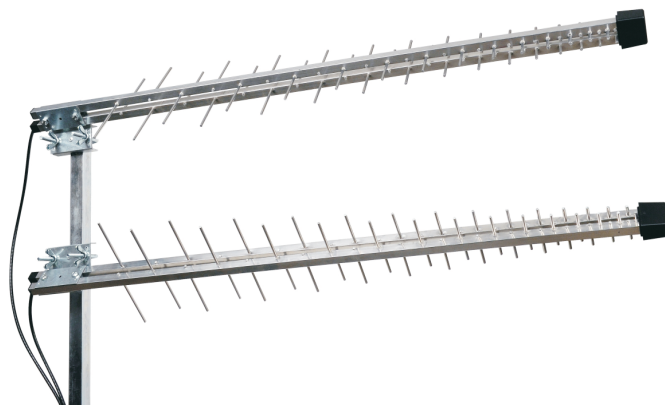

P-56 UNICOM MIMO

Technical data / Tehnični podatki

Type Tip	Channels (frequency) Kanali (frekvenca)	No. of elements Število elementov	Gain Dobitek	F/B ratio Razmerje naprej-nazaj	Beam width Širina glav. lista	Max. VSWR Maks. VSWR	Length Dolžina antene	Packing Pakiranje		
								set kpl.	cm	m ³
P-30 UNICOM MIMO *	LTE 800 (790 - 862 MHz) GSM 900 (880 - 960 MHz) DSC 1800 (1710 - 1880 MHz) UMTS (3G) (1920 - 2170 MHz) Wi-Fi (WLAN) (2401 - 2495 MHz) LTE 2.6 GHz (2.5 - 2.7 GHz)	30	6.5 - 8 dB(i)	23 dB	Horiz. 76° Vert. 68°	<1.5 : 1	45 cm	10	92 x 33 x 29	0.088
P-42 UNICOM MIMO *		42	8 - 9.5 dB(i)	23 dB	Horiz. 64° Vert. 56°		72 cm	5	111 x 34 x 16	0.060
P-56 UNICOM MIMO *		56	9.5 - 11.5 dB(i)	24 dB	Horiz. 52° Vert. 44°		98 cm	5	111 x 34 x 27	0.102
P-58 L700 UNI MIMO **		58	9 - 11 dB(i)	23 dB	Horiz. 54° Vert. 46°		<1.6 : 1	107 cm	5	111 x 34 x 27

* One set contain two antennas (one for upper and one for lower mounting position). Each antenna has 10 m coax. cable and SMA male connector. Gain diagram for each antenna is the same as for standard UNICOM antenna (see previous page on this catalogue). /

En komplet vsebuje dve anteni (eno za zgornjo in eno za spodnjo montažno pozicijo na drogu). Vsaka antena ima 10 m koaks. kabla in SMA moški konektor. Graf dobitka za vsako anteno je enak kot za standardno UNICOM anteno (glej predhodno stran v tem katalogu).

** Antenna P-58 L700 UNI MIMO also covers band LTE 700 (698-790 MHz)

One set contain two antennas (one for upper and one for lower mounting position). Each antenna has 10 m coax. cable and SMA male connector. Gain diagram for each antenna is the same as for standard UNICOM antenna (see previous page on this catalogue). /

Antena pokriva tudi pas LTE 700 (698 - 790 MHz)

En komplet vsebuje dve anteni (eno za zgornjo in eno za spodnjo montažno pozicijo na drogu). Vsaka antena ima 10 m koaks. kabla in SMA moški konektor. Graf dobitka za vsako anteno je enak kot za standardno UNICOM anteno (glej predhodno stran v tem katalogu).

Examples of connection / Primeri priključitve

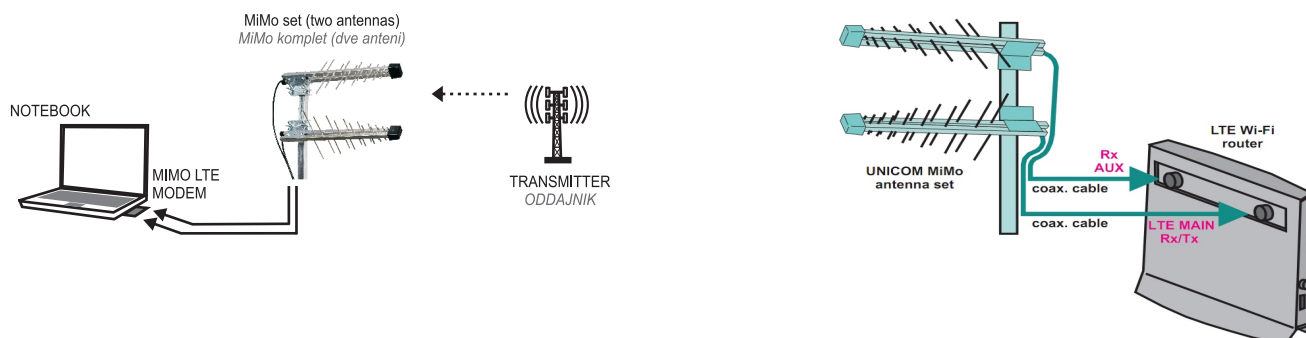



Our antenna amplifiers are designed to amplify weak and medium strong signals on all radio/TV frequency bands. They are very sensitive to very weak signals and low-noise amplification. This is very important at low input levels. Antenna amplifiers are used for amplification of digital and analogue terrestrial channels.

Amplifiers were designed for strong input signals too. High output signal level is used to enable distribution to large number of radio/TV sets. Some amplifiers have built-in splitters, which enables signal distribution to several TV sets (1 / 2 / 4 / 8).

High quality elements and quality production guarantees stable working for long time period.

Antenski ojačevalniki so namenjeni močnemu in kakovostnemu ojačenju šibkih in srednje močnih signalov na vseh RA / TV frekvenčnih področjih.

Odlikujejo jih občutljivost za zelo šibke signale ter nizkošumno ojačanje, kar je zelo pomembno pri nizkih vhodnih nivojih. Uporabljajo se za sprejem in ojačanje digitalnih in analognih zemeljskih kanalov.

Konstrukcija ojačevalnikov je narejena tako, da lahko na vhod pripeljemo tudi močnejše signale, visok izhodni nivo pa potrebujemo za priklop večjega števila TV sprejemnikov. Nekateri ojačevalniki imajo že vgrajene delilnike, kar nam olajša razdelitev signala na več TV sprejemnikov (1 / 2 / 4 / 8).

Kakovostni vgrajeni elementi in temeljita izdelava zagotavljata stabilno in dolgotrajno delovanje.

Types/Tipi:

- Antennas Amplifiers
Antenski ojačevalniki
- Antennas Power Suppliers
Antenski napajalniki
- Couplers
Kretnice
- Accessories
Pribor

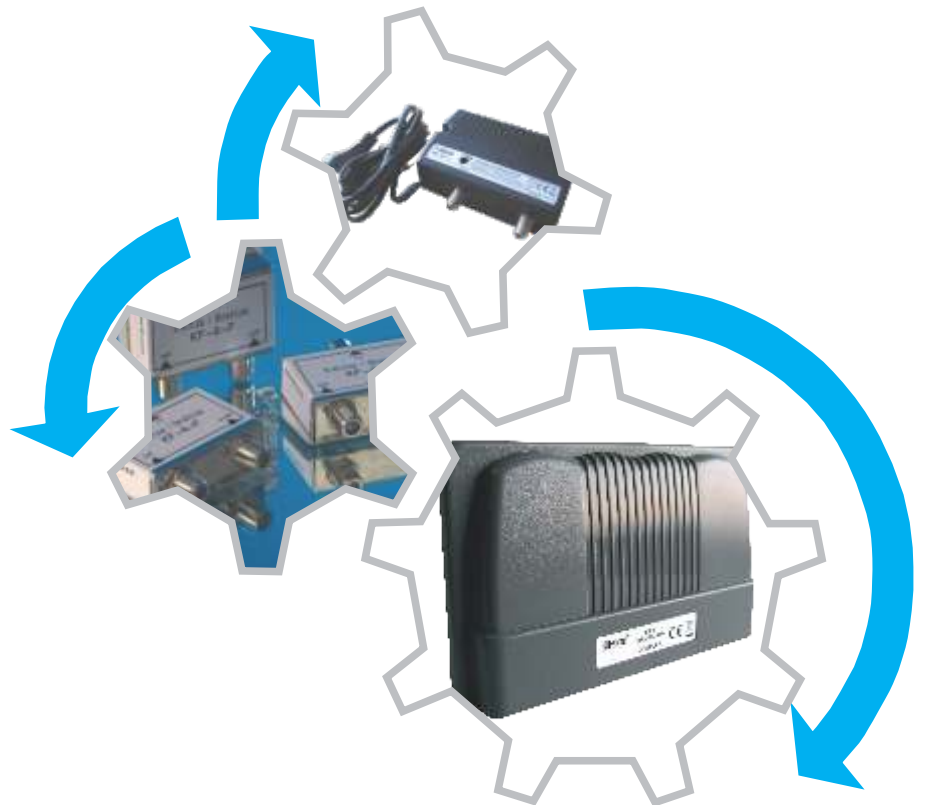



OM-2R/1

Antenna amplifier OM-2R/1 is suitable to amplify antennas, couplers or CATV signals through the coaxial cable. It is used only indoor.

Antenski ojaèevalnik OM-2R/1 je namenjen ojaèenju signala iz anten, kretnic ali CATV prikljuèka. Ojaèevalnik je namenjen le za notranjo uporabo.



OM-2R/2

Antenna amplifier OM-2R/2 is suitable to amplify antennas, couplers or CATV signals through the coaxial cable. It enables signal distribution from antenna input to two outputs (two TV or radio sets). It is used only indoor; screws for fixing on wood are included.

Antenski ojaèevalnik OM-2R/2 je namenjen ojaèenju signala iz anten, kretnic ali CATV prikljuèka. Ima vgrajen delilnik signala za dva TV / RA sprejemnika. Ojaèevalnik je namenjen le za notranjo uporabo. Priloženi so lesni vijaki za montažo na les.



OM-3R/4

Amplifier OM-3R/4 is suitable to amplify signals from antennas through the coaxial cable. It enables signal distribution from antenna input to four outputs (four TV sets). It is used only indoor.

Ojaèevalnik OM-3R/4 je namenjen ojaèenju signalov iz anten prek koaksialnega kabla. Omogoèa prikljuèitev štirih TV sprejemnikov na antensko instalacijo. Ojaèevalnik je namenjen le za notranjo uporabo.



OM-3R/8

Amplifier OM-3R/8 is suitable to amplify signals from antennas through the coaxial cable. It enables signal distribution from antenna input to eight outputs (eight TV sets). It is used only indoor.

Ojaèevalnik OM-3R/8 je namenjen ojaèenju signalov iz anten preko koaksialnega kabla. Omogoèa, da na antensko instalacijo prikljuèimo osem TV sprejemnikov. Ojaèevalnik je namenjen le za notranjo uporabo.

Technical data / Tehnièni podatki

Type Tip	Power supply Omrežna napetost	Channels (frequency) Kanali (frekvenca)	No. of inputs/outputs St. vhodov/izhodov	Amplification Ojaèenje	Gain control Regulacija ojaèenja	Noise figure Sumno število	Max. output level Maks. izhodni nivo signala
OM-2R/1	AC 230 V 50 Hz	40 - 862 MHz	1 / 1	25 dB	0 - 10 dB	6 dB	87 dBmV
OM-2R/2			1 / 2	26 dB		5 dB	85 dBmV
OM-3R/4			1 / 4	24 dB		6 dB	85 dBmV
OM-3R/8			1 / 8	20 dB		6 dB	90 dBmV



OM-3RS

CATV antenna amplifier OM-3RS is suitable to amplify antennas, couplers or CATV input through the coaxial cable. It has two regulations: amplification and slope. It has built-in return path for using internet via CATV network. It is used only indoor. Screws for fixing on wood are included.

CATV antenski ojaèevalnik OM-3RS je namenjen ojaèanju signala iz anten, kretnic ali CATV prikljuèka. Ima regulacijo ojaèenja in nagiba krivulje. Prav tako ima vgrajen povratni pas za uporabo interneta preko CATV omrežja. Ojaèevalnik je namenjen le za notranjo uporabo. Priloženi so lesni vijaki za montažo na les.

Technical data / Tehnièni podatki

Type Tip	Power supply Omrežna napetost	Channels (frequency) Kanali (frekvenca)	Amplification Ojaèanje	Gain control Regulacija ojaèanja	Slope control Regulacija nagiba krivulje	Noise figure Sumno število	Return path Povratni pas	Max. output level Maks. izhodni nivo signala
OM-3RS	AC 230 V 50 Hz	40 - 862 MHz	23 dB	3 - 23 dB	-1 ... 18 dB	7 dB max.	5 ... 30 MHz, -2 dB	105 dBmV



SUR-211
SUR-212

antenna with amplifier DIGI-LOG
antena z ojačevalnikom DIGI-LOG

coax. cable
koaks. kabel

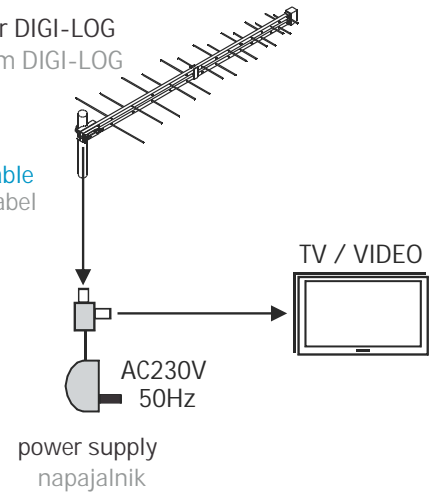

power supply
napajalnik

Technical data / Tehnični podatki

Type Tip	Power supply Omrežna napetost	Impedance Impedanca	Output voltage Izhodna napetost	Max. output current Maksimalni izhodni tok	Connection to antenna (input) Konektor za priklop antene (vhod)	Connection to TV set (output) Konektor za priklop na TV (izhod)	Packing Pakiranje		
							pcs. kom	cm	m ³
SUR-211	AC 230 V	75 Ohm	DC 12 V	100 mA	1 x "F" female 1 x "F" ženski	1 x IEC 169-2 male 1 x IEC 169-2 moški	1	8 x 5 x 9	0.0004
SUR-212				200 mA			100	42 x 27 x 38	0.043



SUR-210/2

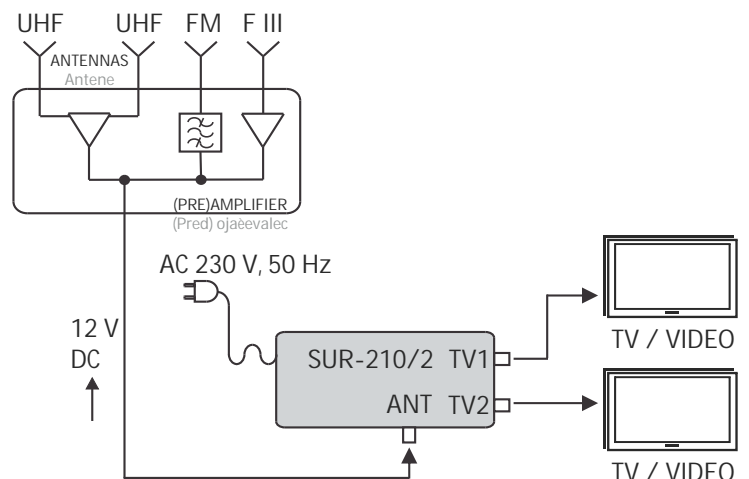

Technical data / Tehnični podatki

Type Tip	Power supply Omrežna napetost	Impedance Impedanca	Output voltage Izhodna napetost	Max. output current Maksimalni izhodni tok	Connection to antenna (input) Konektor za priklop antene (vhod)	Connection to TV set (output) Konektor za priklop na TV (izhod)	Packing Pakiranje		
							pcs. kom	cm	m ³
SUR-210/2	AC 230 V	75 Ohm	DC 12 V	150 mA	1 x "F" female 1 x "F" ženski	2 x "F" female 2 x "F" ženski	1	11 x 4.5 x 13.5	0.00067
							20	27.5 x 26 x 39	0.028



KR-F

Antenna coupler KR-F is suitable to combine several antennas into one output. It can be mounted into mast (PVC strip included), beam or wall (mounting material is not included). It can be used outdoor or indoor.

Antenska kretnica KR-F se uporablja za združevanje večih anten v en izhod. Lahko jo pritrdimo na antenski drog (vezica priložena) ali na les oz. zid (vijaki niso priloženi). Namenjena je za zunanjo ali notranjo uporabo.



KR-F

Technical data / Tehnični podatki

Type Tip	Input 1 Vhod 1	Input 2 Vhod 2	Input 3 Vhod 3	Impedance Impedanca	Connections Priključki
KR-F UHF, UHF+	UHF (470 - 870 MHz)	UHF (470 - 870 MHz) with power pass s prehodom napetosti	/	75 Ohm	3 x "F" female 3 x "F" ženski
KR-F VHF, UHF, UHF+	VHF (5 - 300 MHz)	UHF (470 - 870 MHz)	UHF (470 - 870 MHz) with power pass		
KR-F UHF, UHF, UHF+	UHF (470 - 870 MHz)		s prehodom napetosti		



KF-4-F

Coupler KF-4-F is used to combine two or three antennas into one output. It is used only indoor, usually in the attic, near antennas. It can be mounted on the beam or wall. Coupler KF-4-F is packed into polybag with hanging carton.

Antenske kretnice KF-4-F se uporabljajo za združevanje dveh ali treh anten v en izhod. Namenjene so le za notranjo uporabo, običajno na podstrešju, čim bližje antenam. Lahko jo montiramo na tram ali na zid. Kretnica je pakirana v vrečko z obešanko.

Technical data / Tehnični podatki

Type Tip	No. of inputs St. vhodov	Input 1 Vhod 1	Input 2 Vhod 2	Input 3 Vhod 3	Impedance Impedanca	Connections Prključki	Insertion loss Prehodno slabljenje
KF-4-F 5-69 UHF	2	Ch. 5 - 69 (174-862 MHz)	Ch. 21 - 69 (470-862 MHz)	/	75 Ohm	"F" female "F" ženski	2.5 dB
KF-4-F UHF, UHF, VHF	3	Ch. 21 - 69 (470-862 MHz)	Ch. 21 - 69 (470-862 MHz)	Ch. 5 - 12 (174-230 MHz)			
KF-4-F UHF, UHF	2	Ch. 21 - 69 (470-862 MHz)	Ch. 21 - 69 (470-862 MHz)	/			
KF-4-F UHF, VHF	2	Ch. 21 - 69 (470-862 MHz)	Ch. 5 - 12 (174-230 MHz)	/			

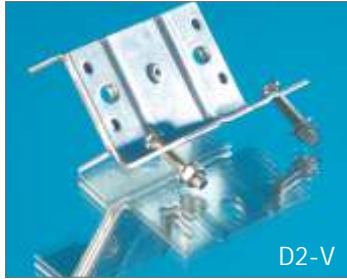

D2-V

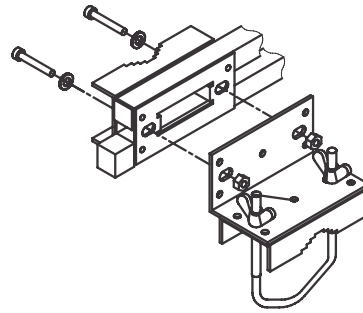

Vertical mounting part D2-V is used as additional part for LOG antennas. LOG antennas can be used for vertical polarisation with D2-V part. It has to be mounted on LOG antenna with screws, washers and nuts (included).

Vertikalni pritrdilec D2-V se uporablja kot dodatni montažni element za LOG antene. Z njim lahko pritrdimo LOG anteno na drog za uporabo antene pri vertikalni polarizaciji. Vgradi se na LOG anteno z vijaki, podložkami in maticami (so priloženi).

We offer complete assortment of terrestrial and satellite antenna systems accessories.

Nudimo vam tudi kompleten pribor za zemeljske in satelitske antenske sisteme.



Splitters (2-8 TV outputs)
Kretnice (2-8 TV izhodov)



Connectors & Adapters (different types)
Konektorji in adapterji (različni tipi)



Different antenna carriers
Različni nosilci anten



Mast brackets
Pritrdilci za drogove



Coaxial cables (50 W, 75 W) & Extensions
Koaksialni kabli (50 W, 75 W) in podaljški



Satellite systems
Satelitski sistemi



www.iskra.eu

Contacts:

E-mail: iskra@iskra.eu

Phone: +386 1 500 44 04

Kontakti:

E-pošta: iskra@iskra.eu

Tel.: 01 500 44 04



Iskra, d.d.
Stegne 21
SI-1000 Ljubljana
Slovenija
Tel.: +386 1 51 31 000

www.iskra.eu
iskra@iskra.eu